

TYPICAL DEPRESSION 2" OR LESS
SYMBOL ON PLAN DS2

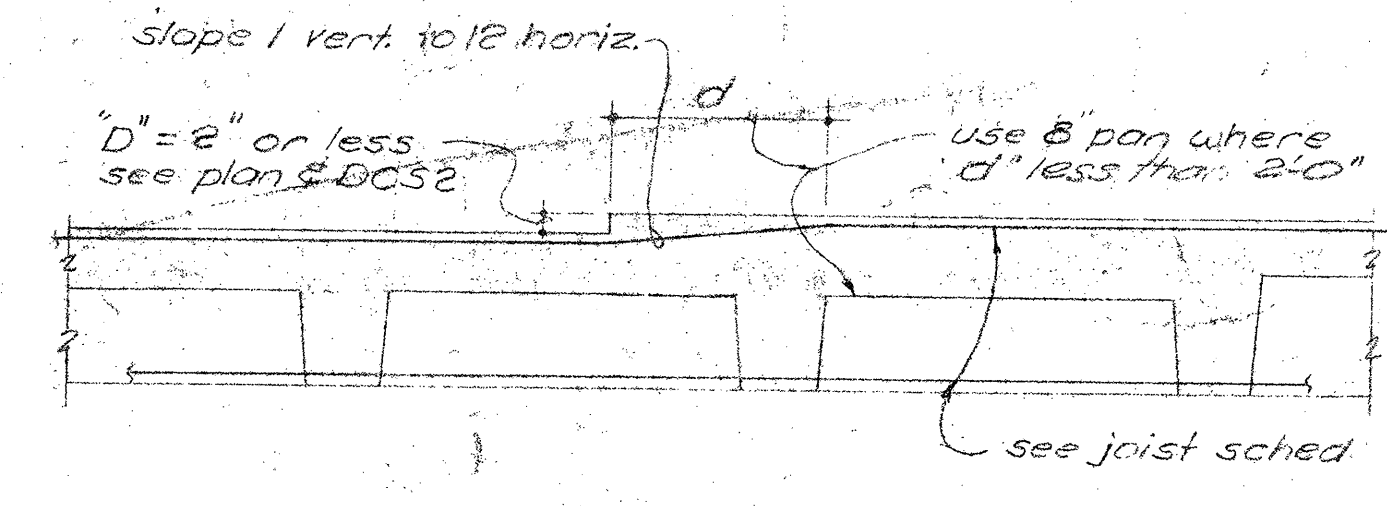

TYPICAL DEPRESSION 2" OR LESS
SYMBOL ON PLAN CS2

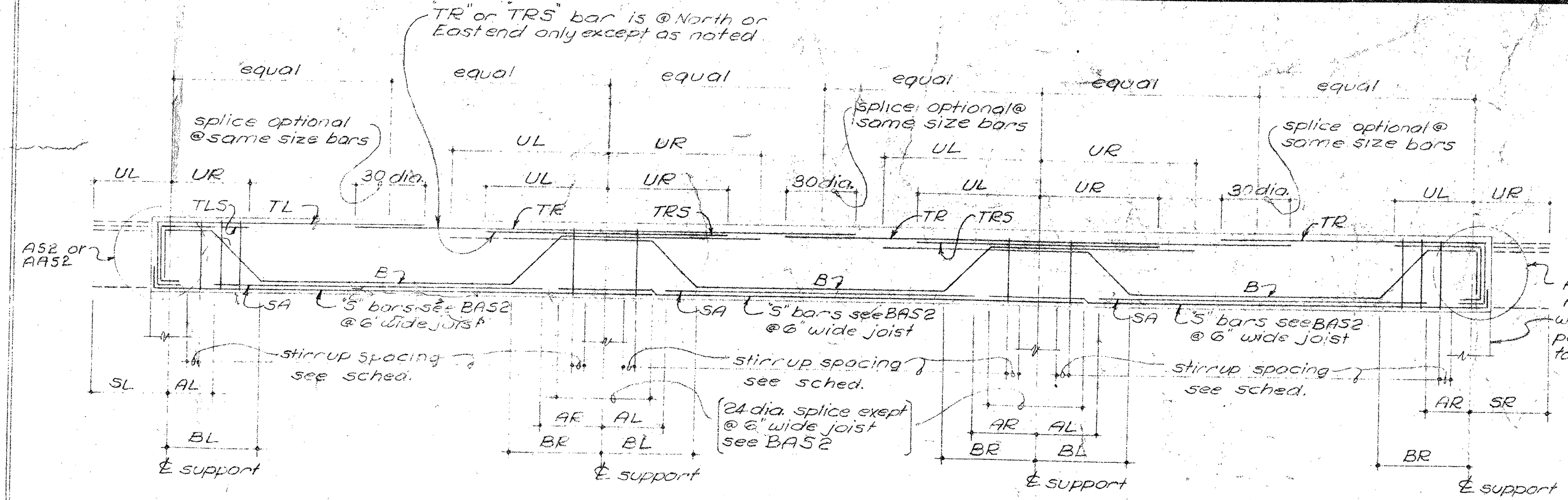

TYPICAL DETAIL AT EDGE OF WAFFLE JOIST OR OPENING
AS2

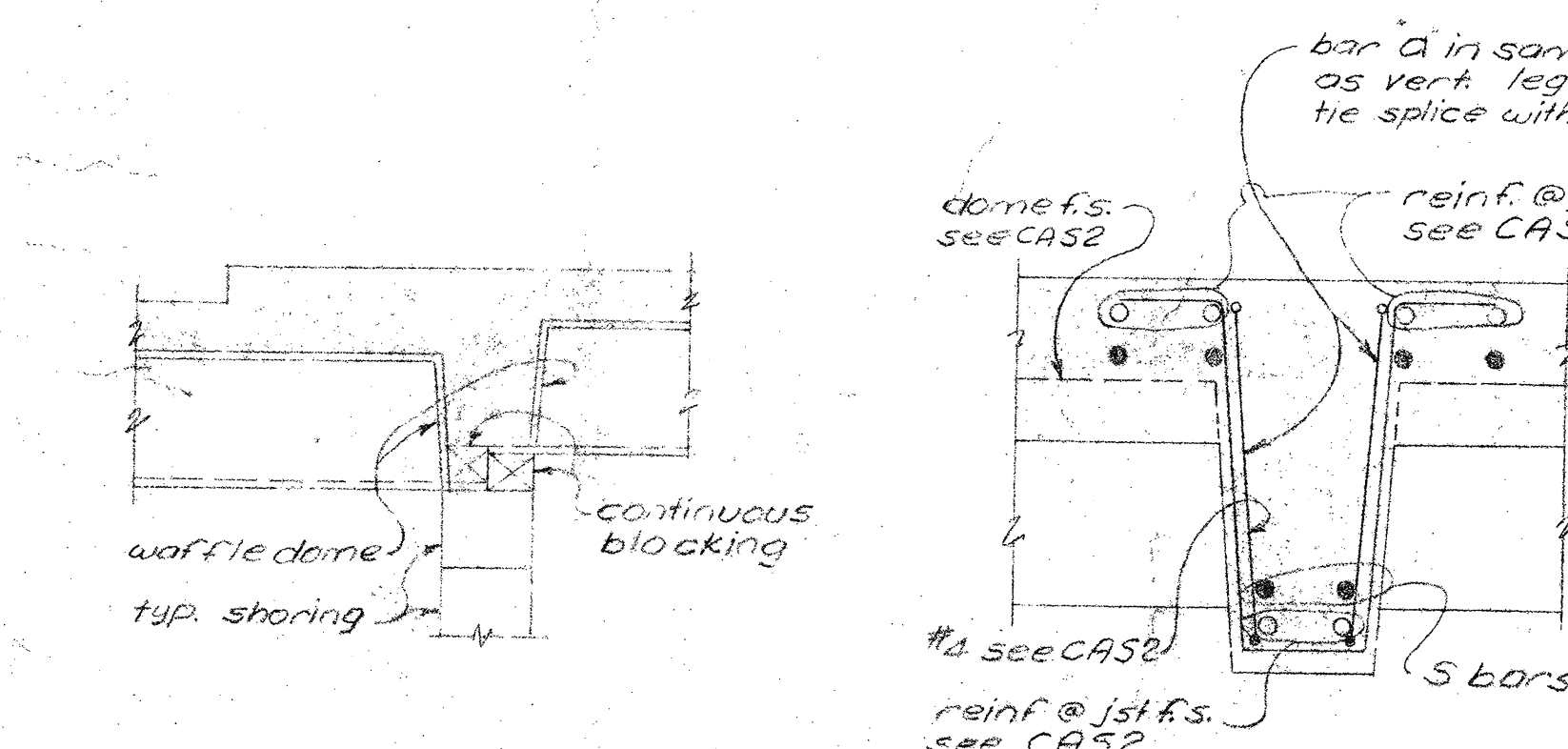

SUGGESTED DETAIL AT SOFFIT DEPRESSION
DBS2

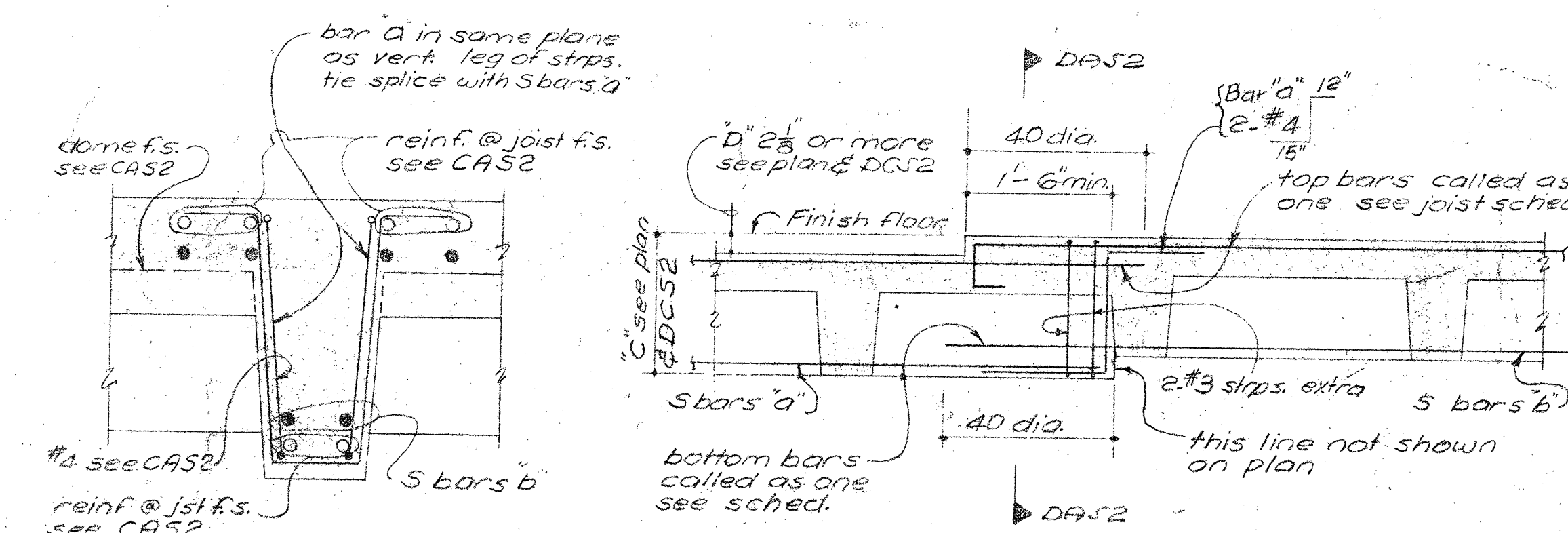

TYPICAL SECTION DEPRESSION 2" OR MORE
DAS2

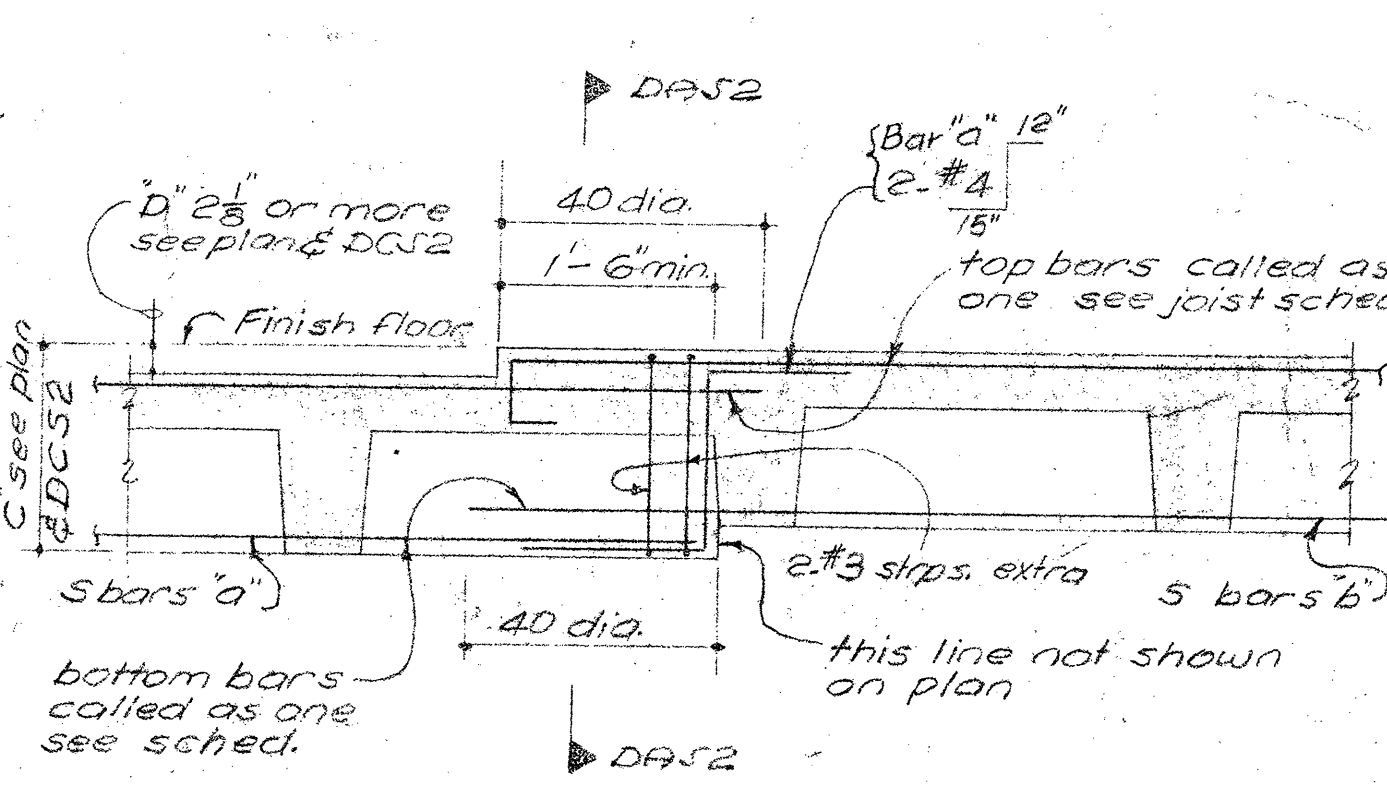

TYP. DEPRESSION 2" OR MORE
SYMBOL ON PLAN CAS2

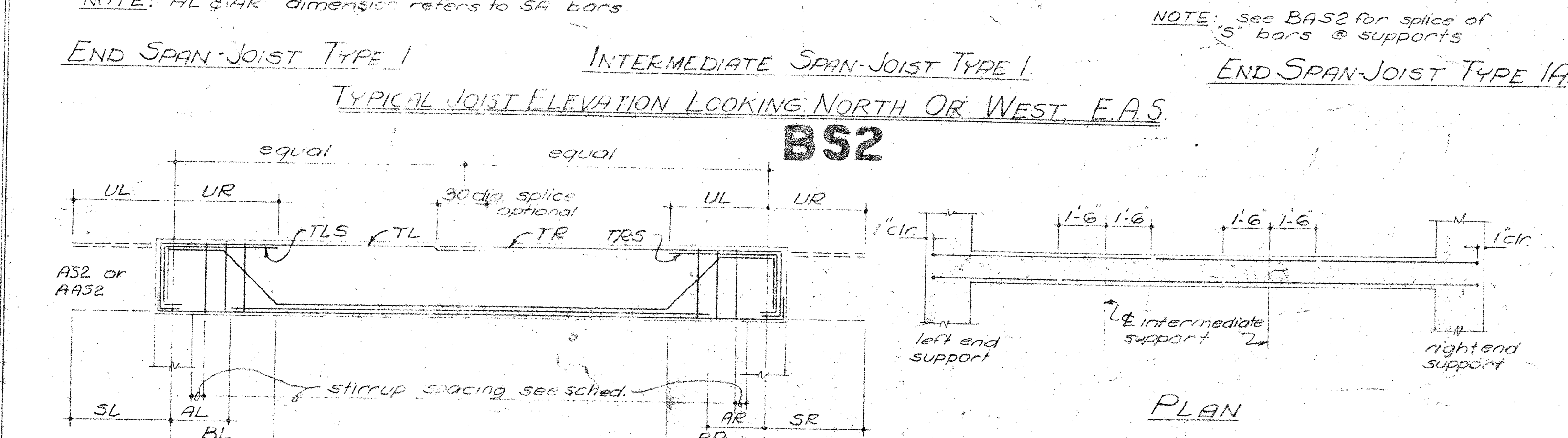

END SPAN JOIST TYPE I INTERMEDIATE SPAN JOIST TYPE I
TYPICAL JOIST ELEVATION LOOKING NORTH OR WEST
BS2

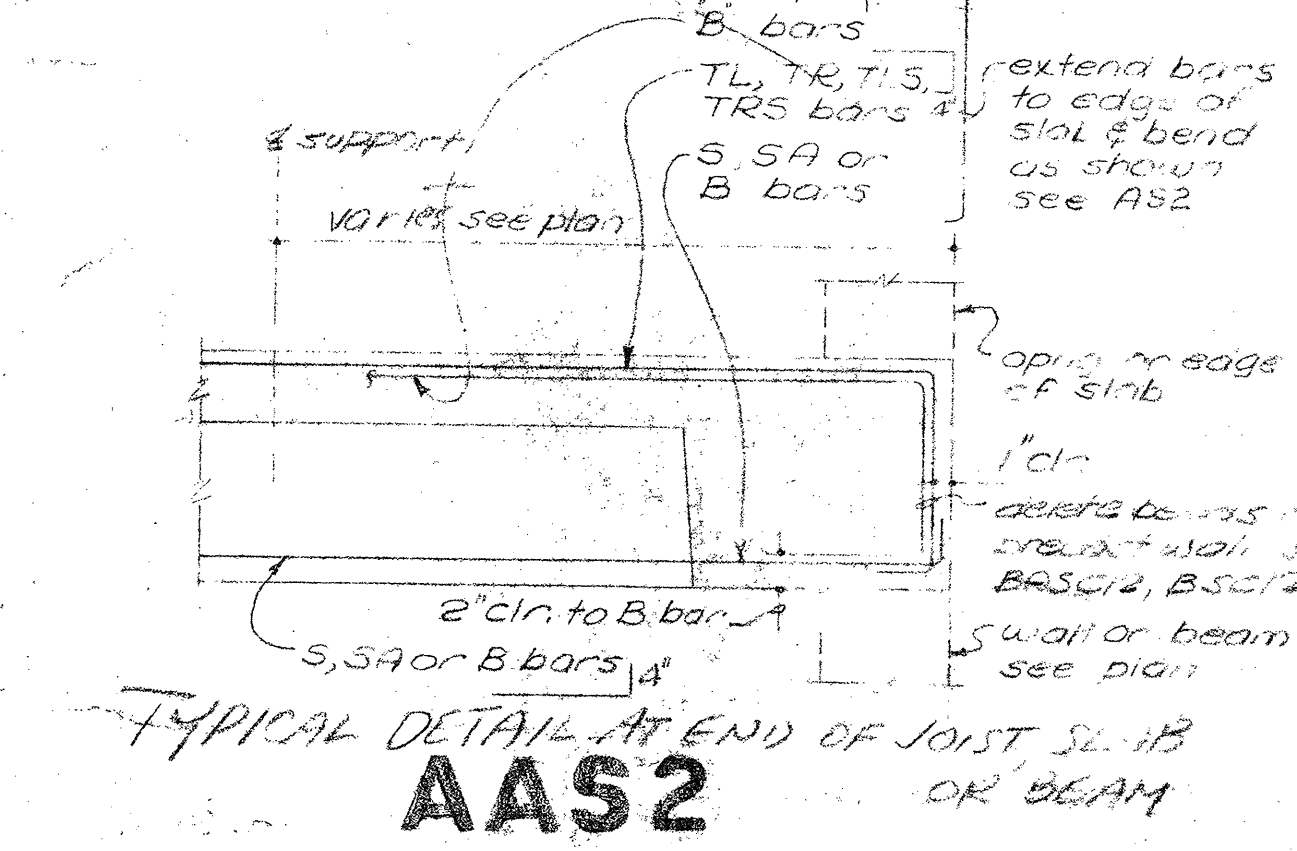

TYPICAL DETAIL AT END OF JOIST SLAB OR BEAM
AAS2

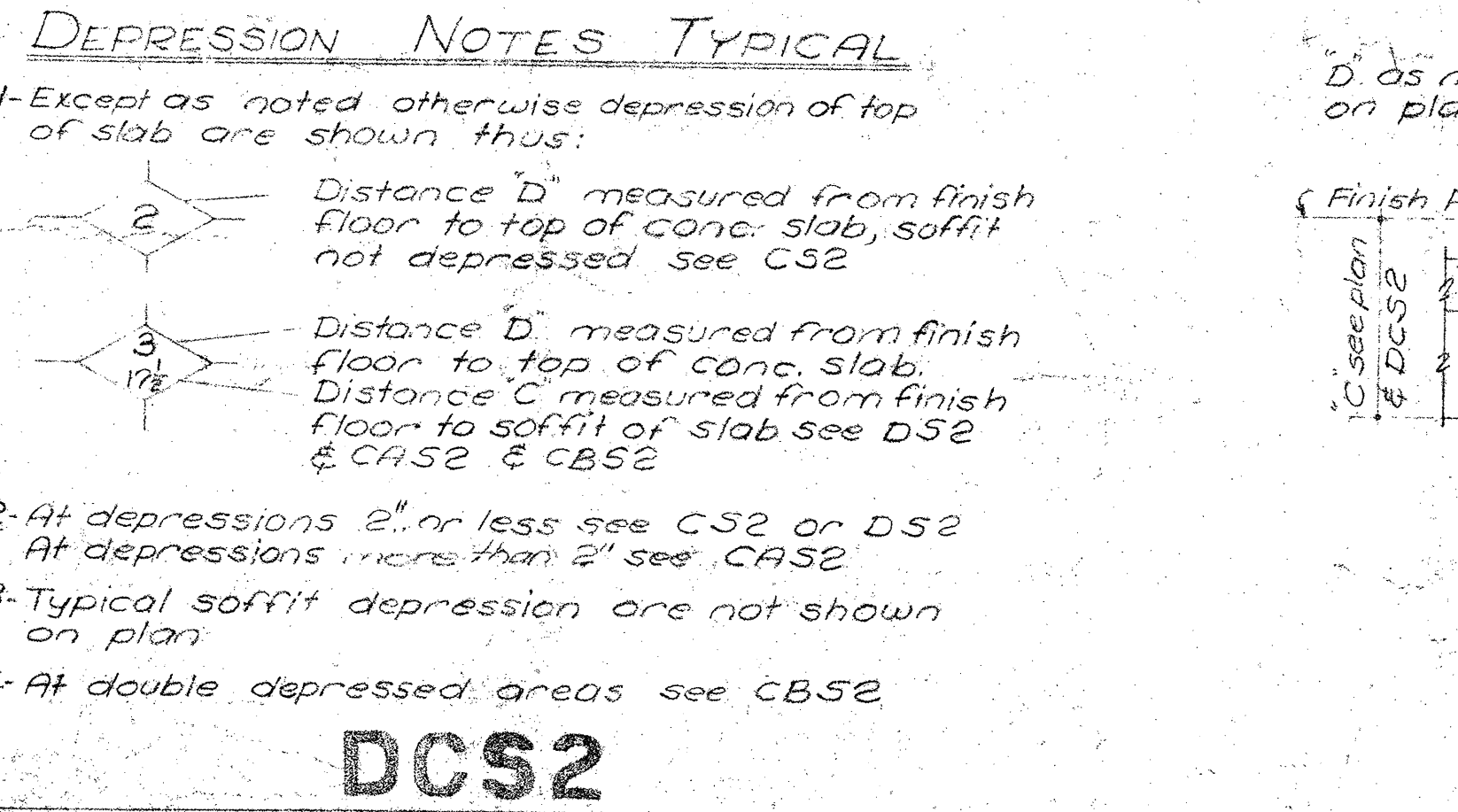

DCS2

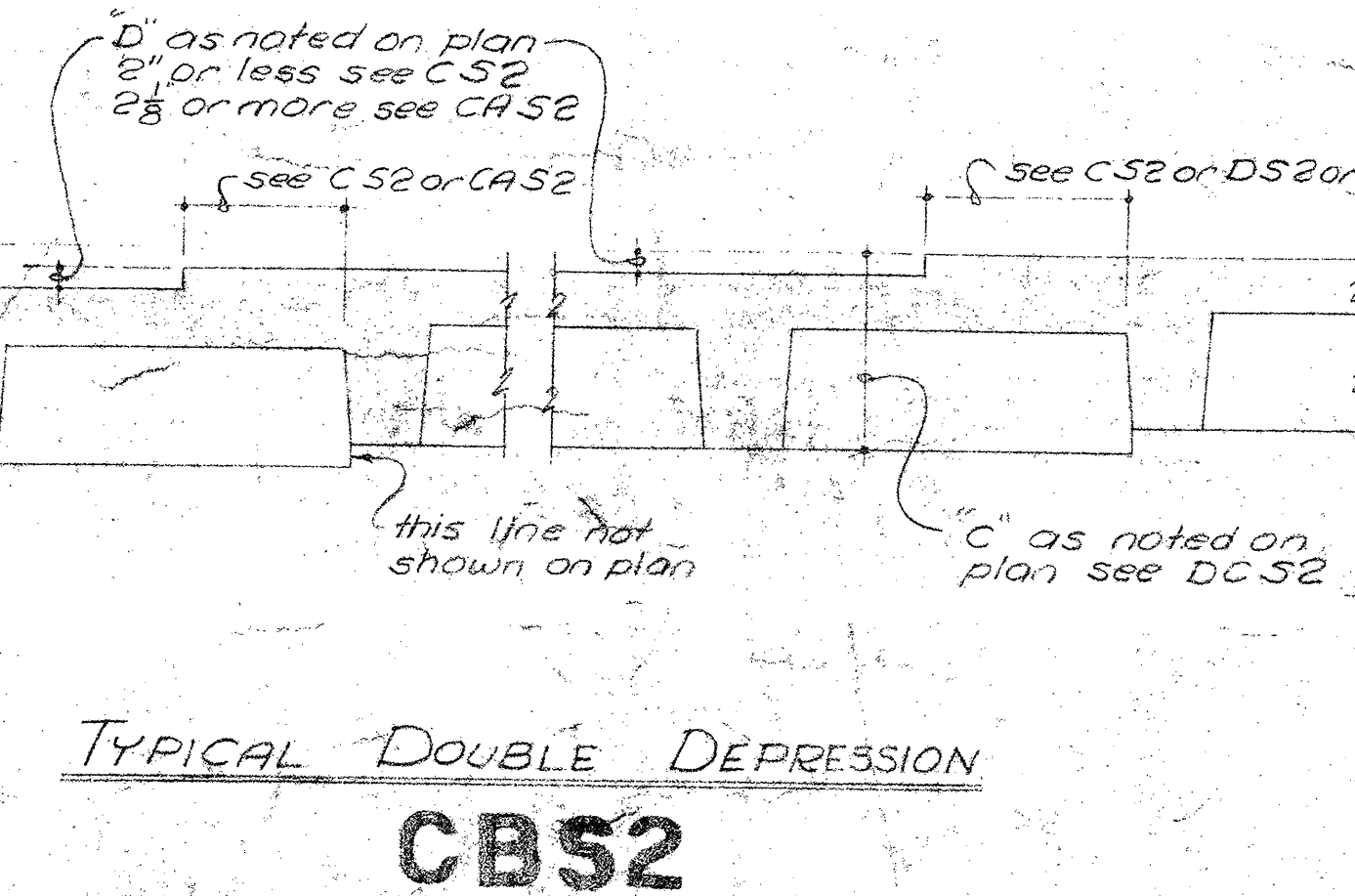

TYPICAL DOUBLE DEPRESSION
CBS2

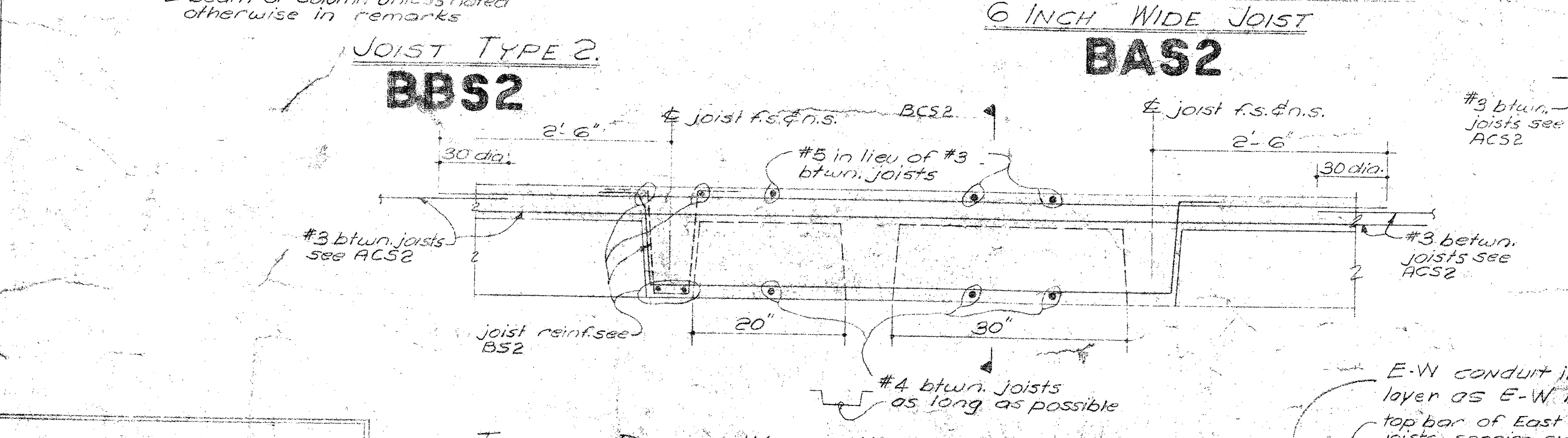

JOIST TYPE 2
BBS2

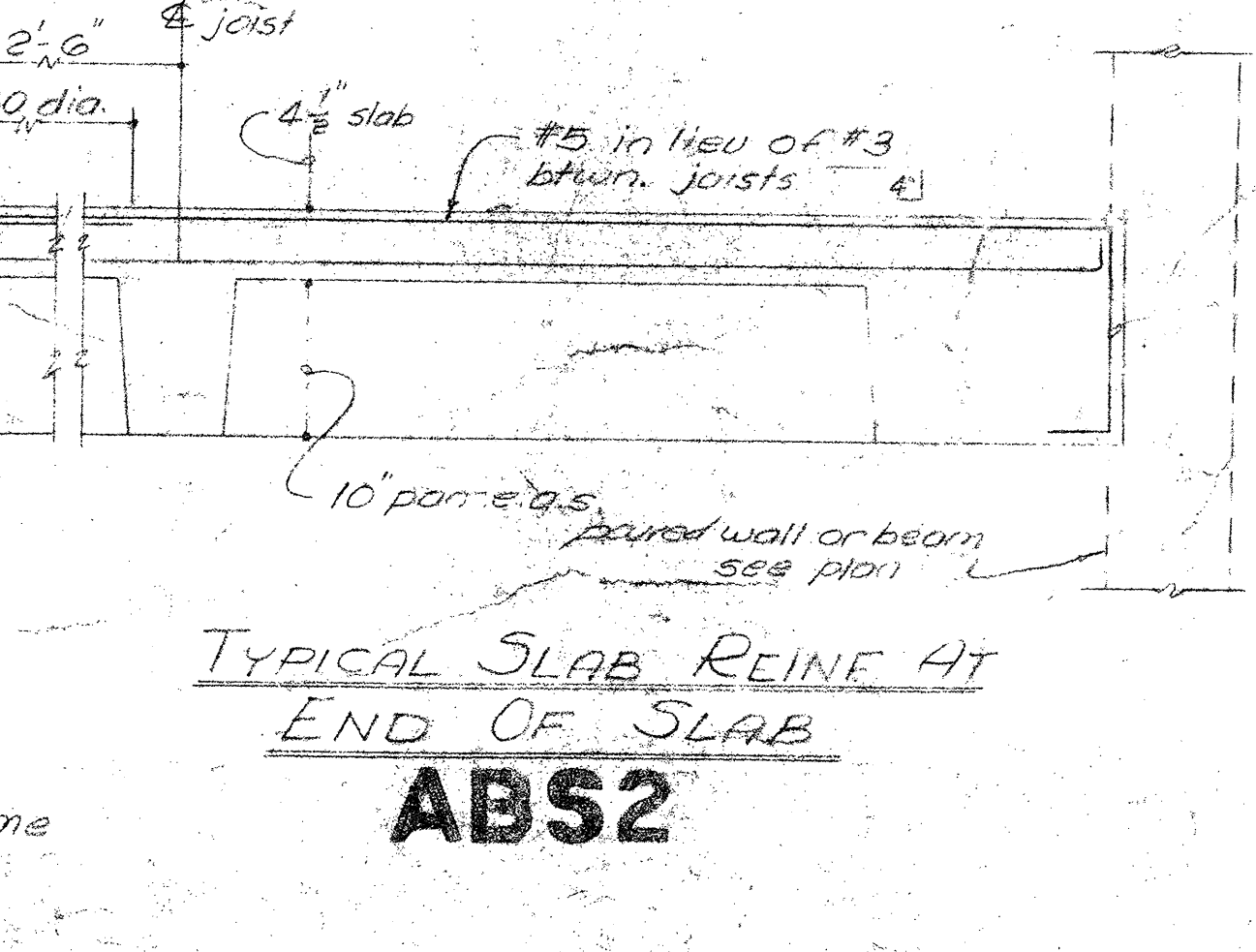

TYPICAL SLAB REINF. AT END OF SLAB
ABS2

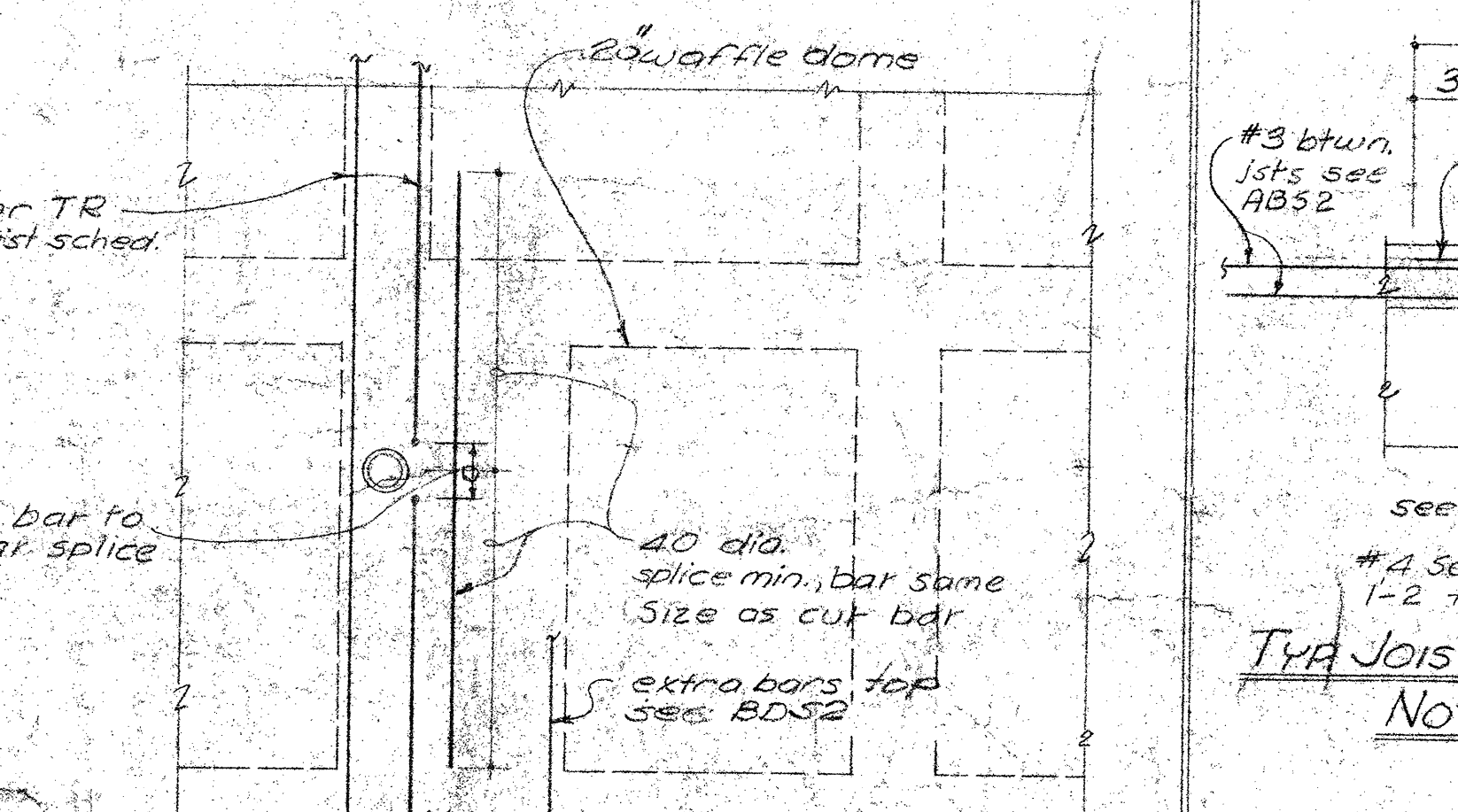

TYP. JOIST PARALLEL TO OPNG. JOIST REINF. NOT CALLED IN SCHED.
CDS2

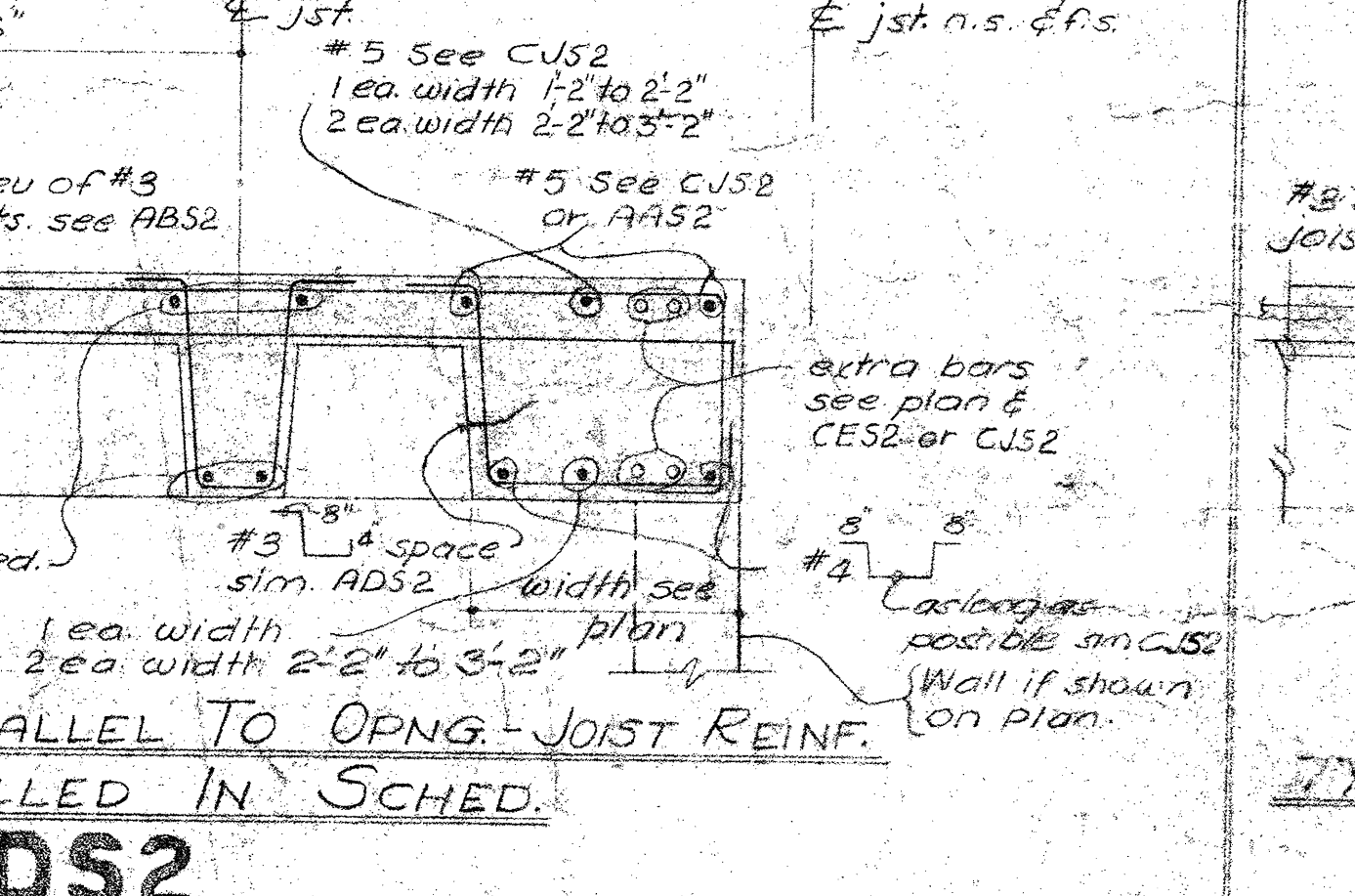

TYP. DETAIL WHERE EXTRA BARS CALLED ON PLAN
CES2

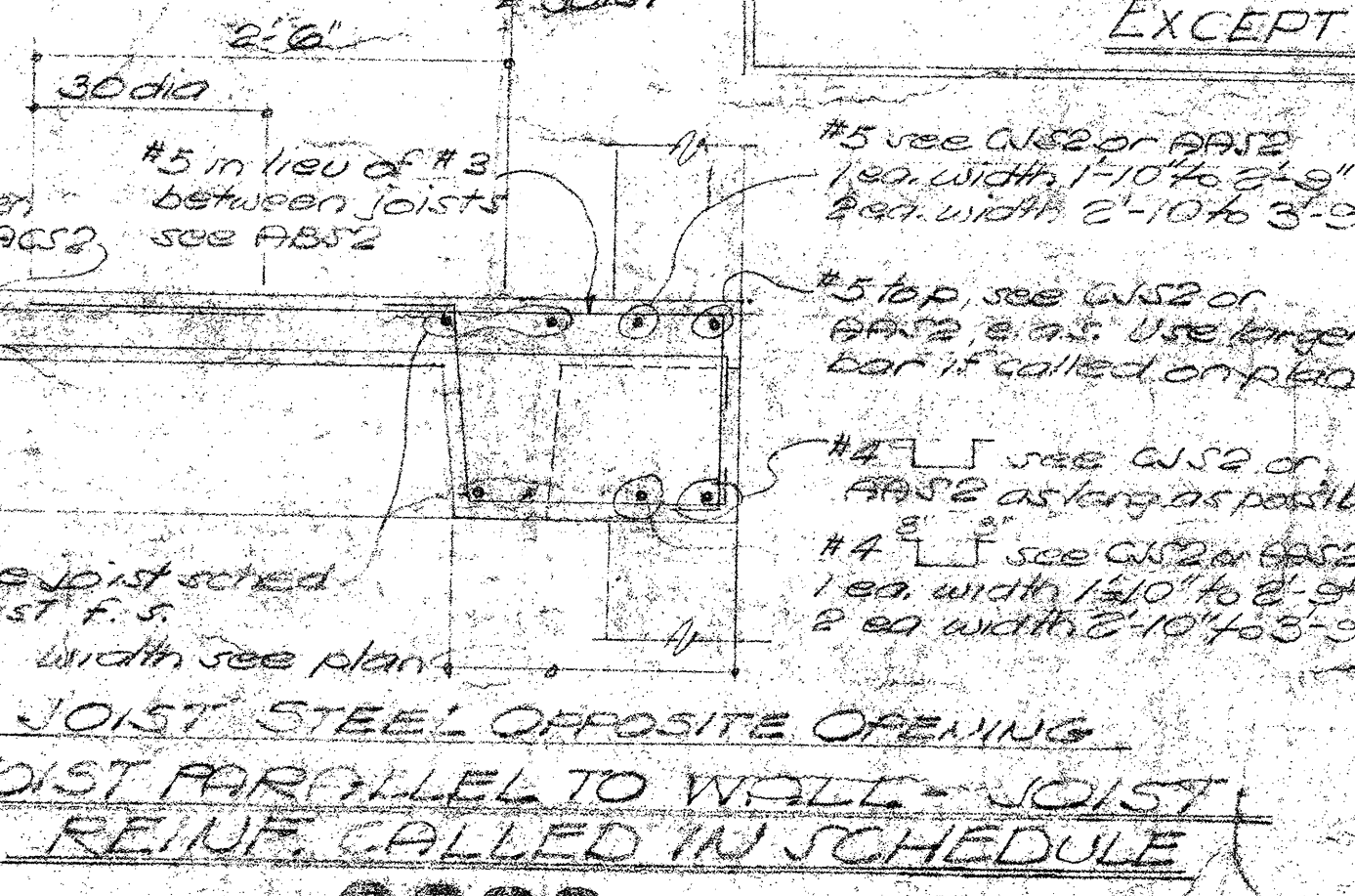

TYP. JOIST PARALLEL TO WALL. JOIST REINF. CALLED IN SCHEDULE
CCS2

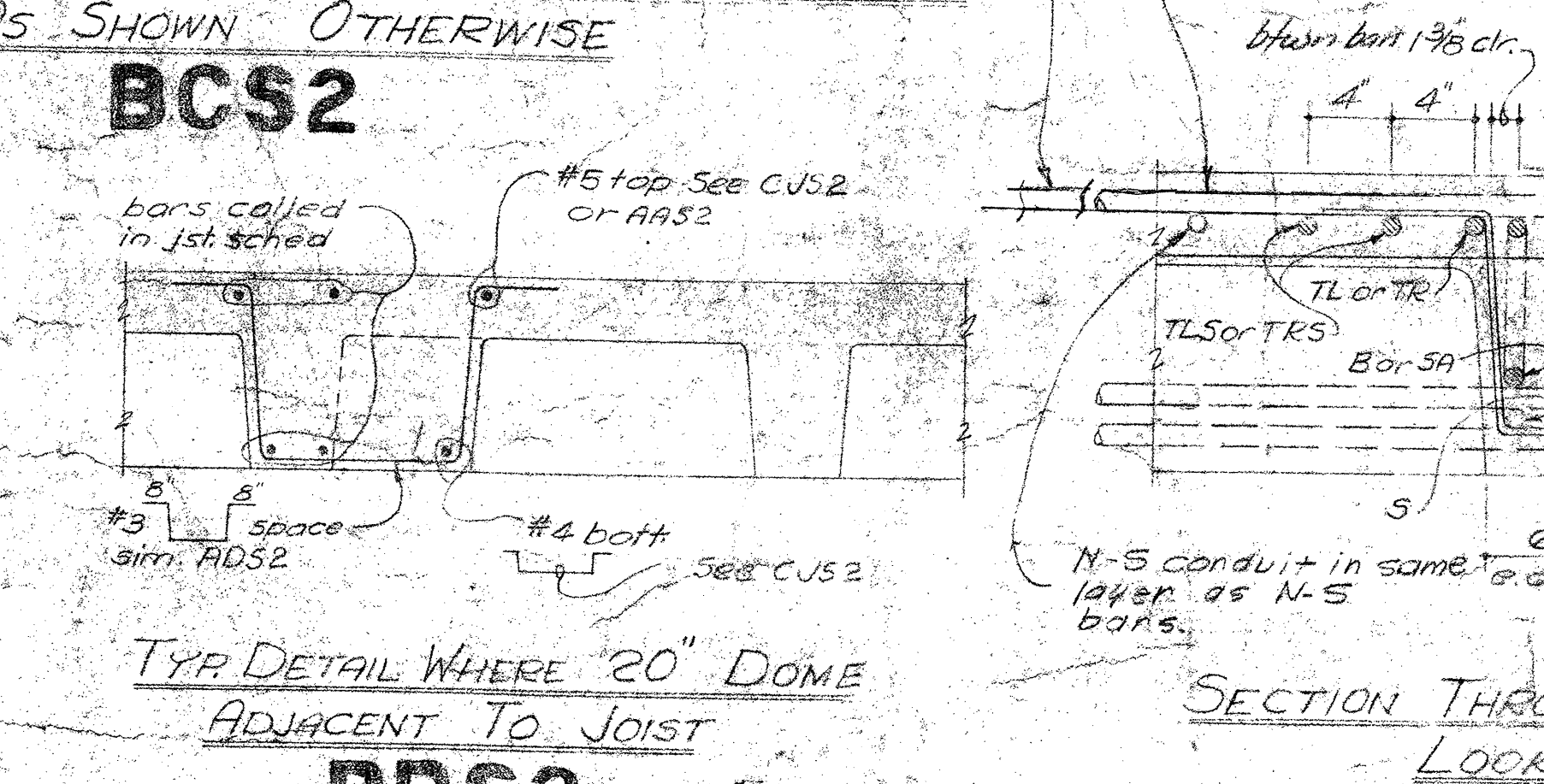

TYP. DETAIL WHERE 20" DOME ADJACENT TO JOIST
BDS2

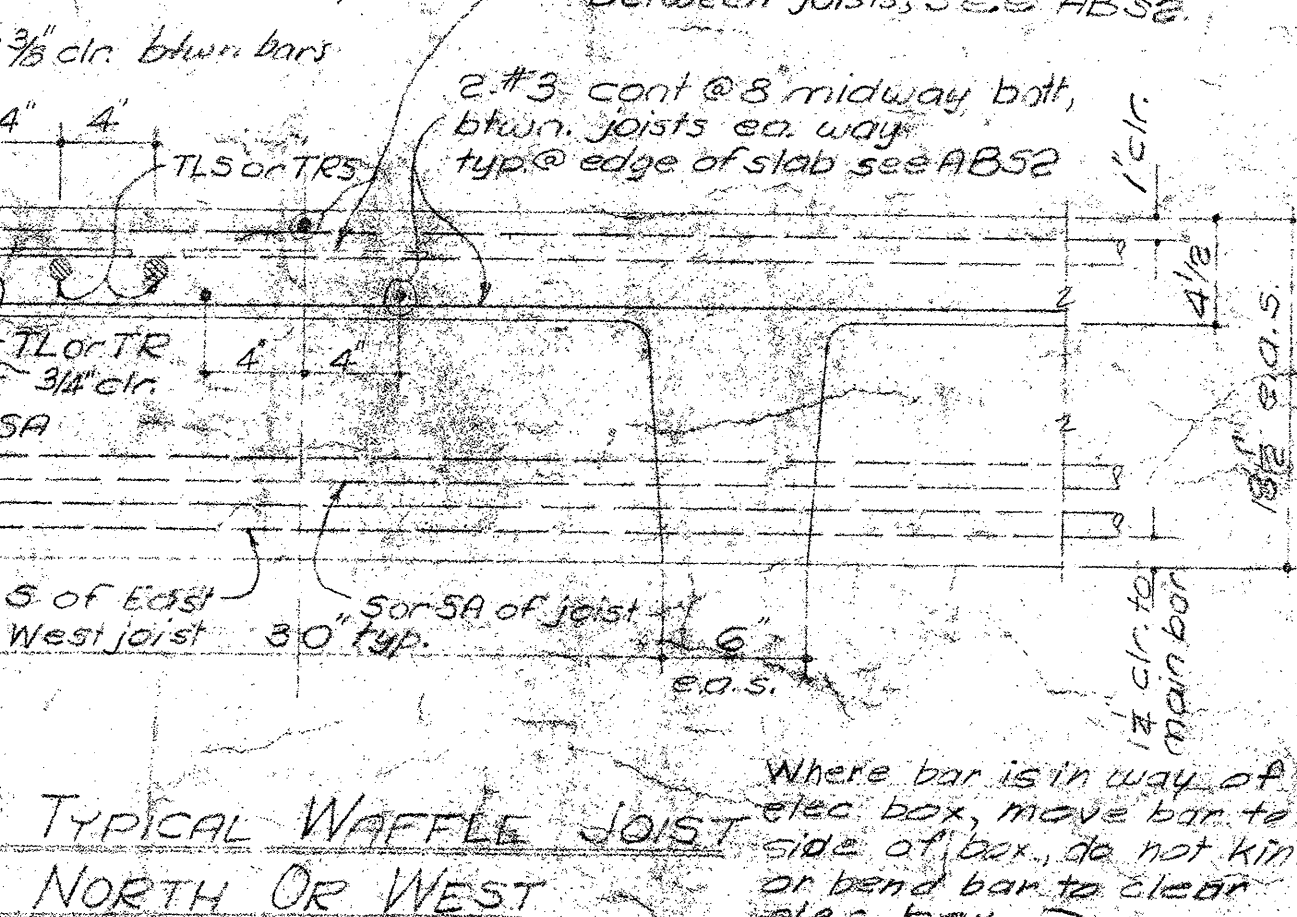

SECTION THROUGH TYPICAL WAFFLE JOIST LOOKING NORTH OR WEST
ACS2

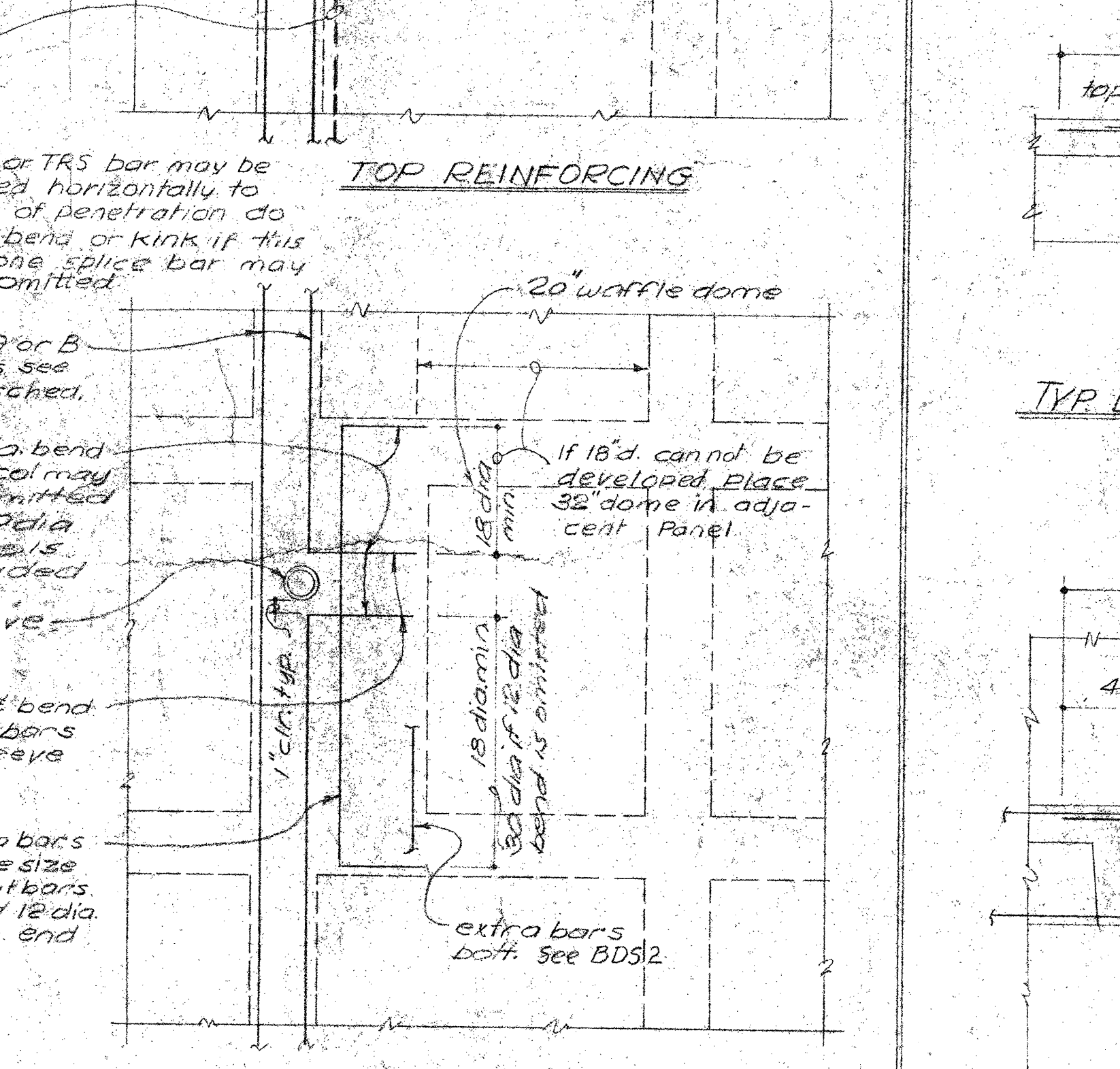

TYP. DETAIL AT SLEEVE PENETRATION THROUGH JOIST
DDS2

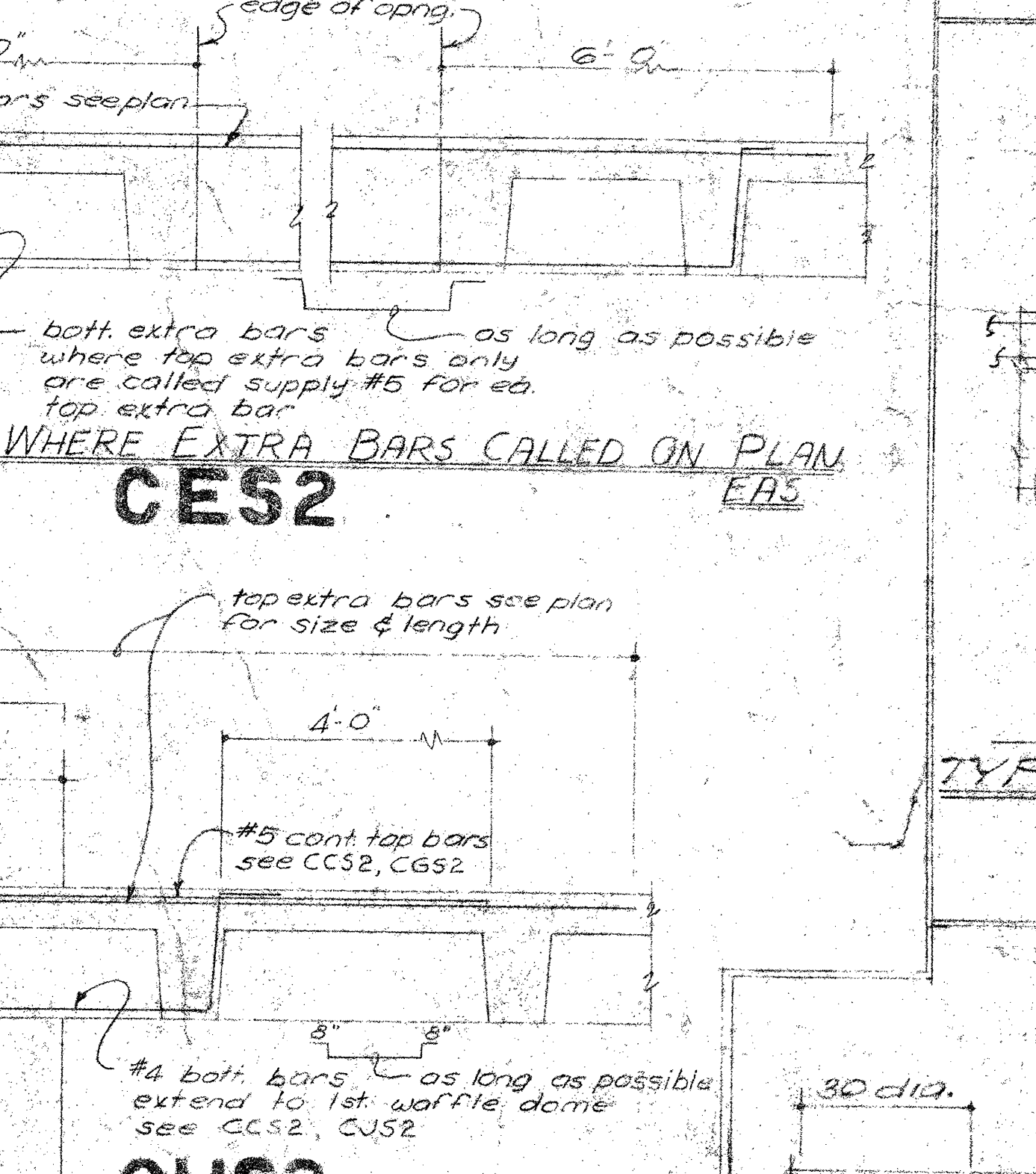

TYP. DETAIL WHERE EXTRA BARS CALLED ON PLAN
CHS2

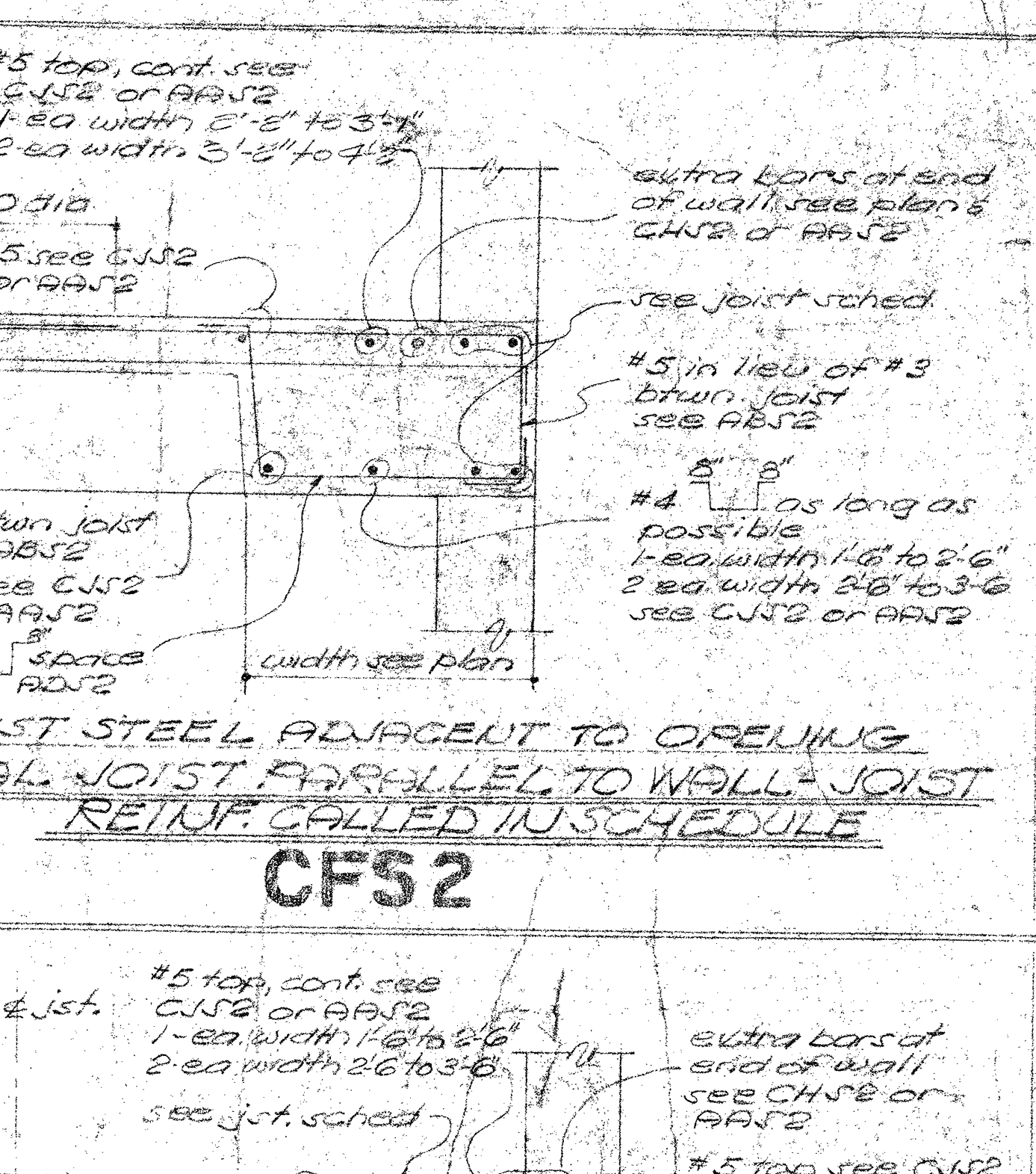

TYPICAL JOIST PARALLEL TO WALL. JOIST REINF. CALLED IN SCHEDULE
CFS2

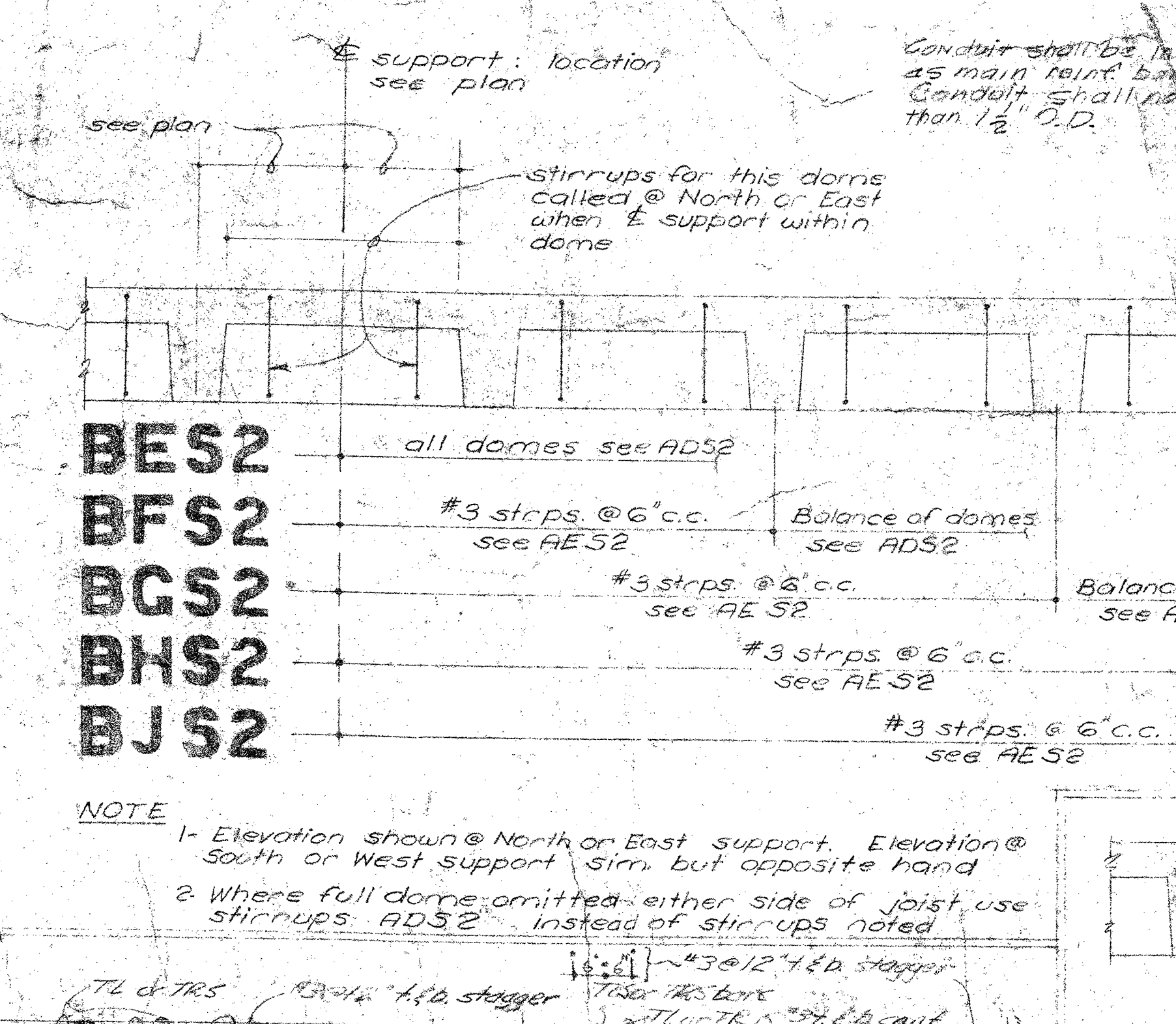

TYP. DETAIL WHERE 20" DOME ADJACENT TO JOIST
BCS2

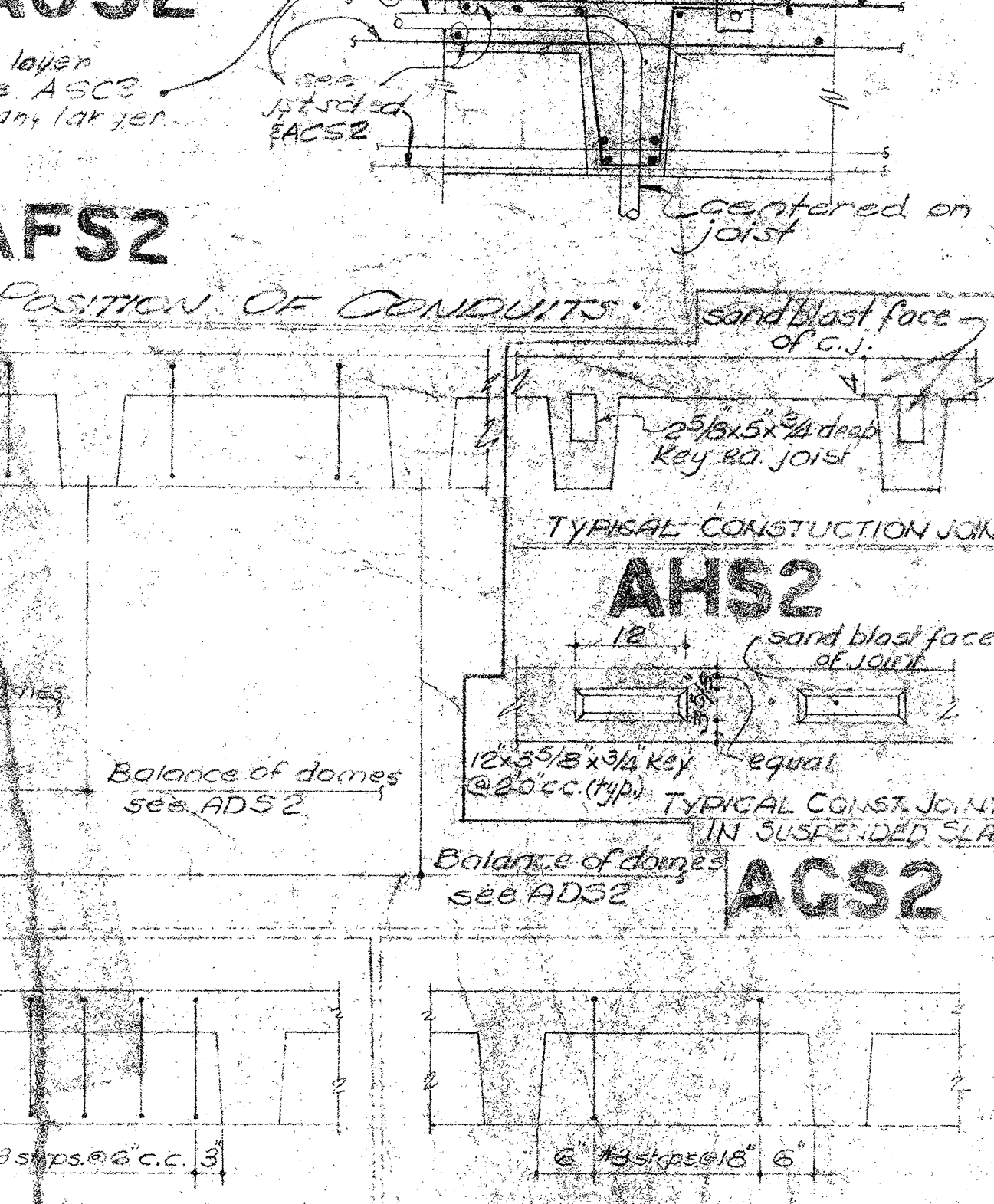

POSITION OF CONDUITS
AFS2

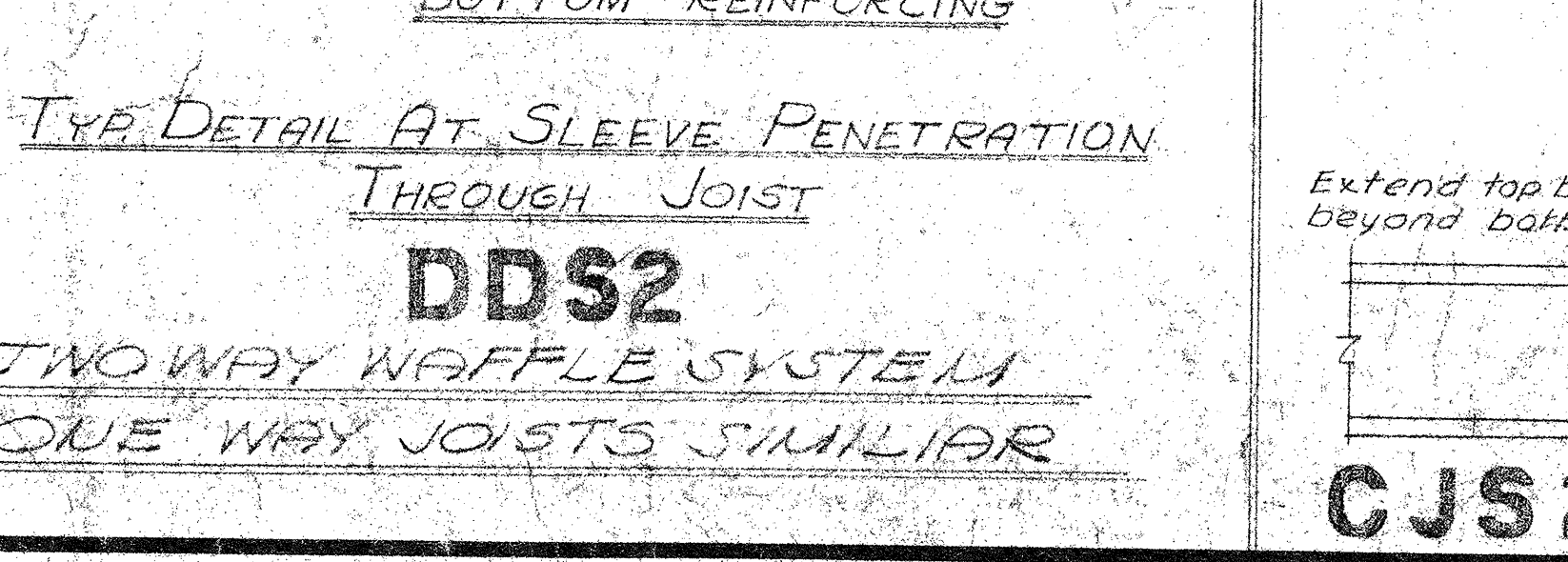

TYP. DETAIL AT SLEEVE PENETRATION THROUGH JOIST
CJS2

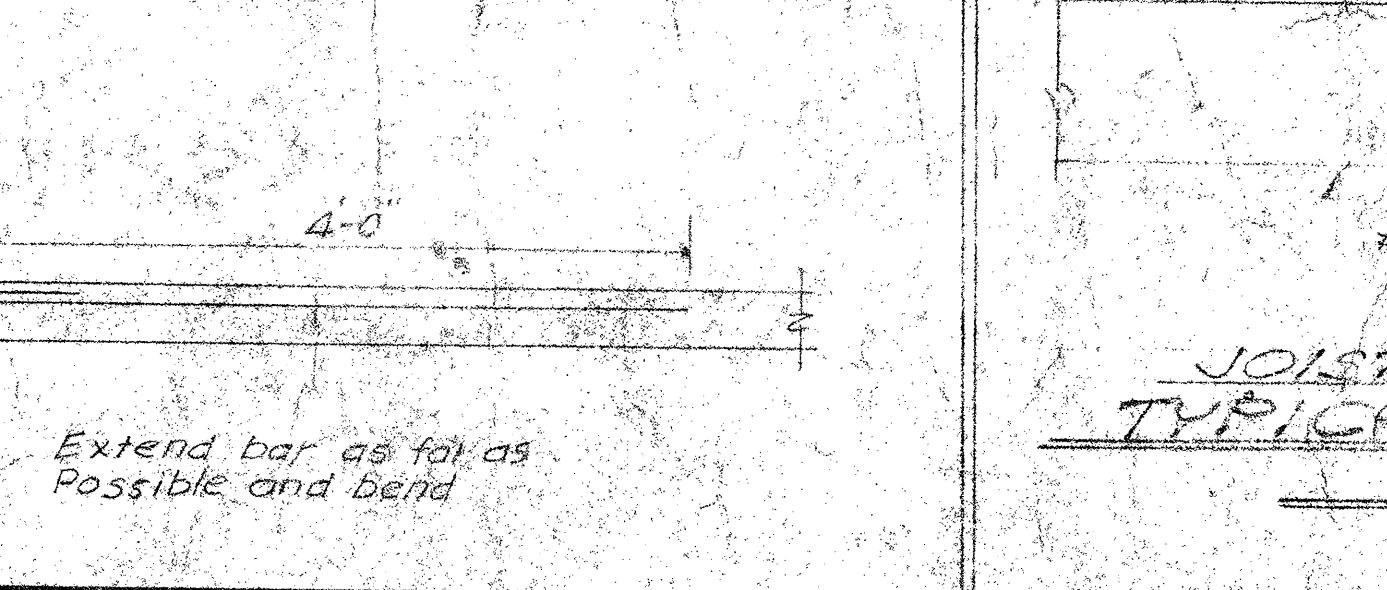

TYP. DETAIL WHERE EXTRA BARS CALLED ON PLAN
CHS2

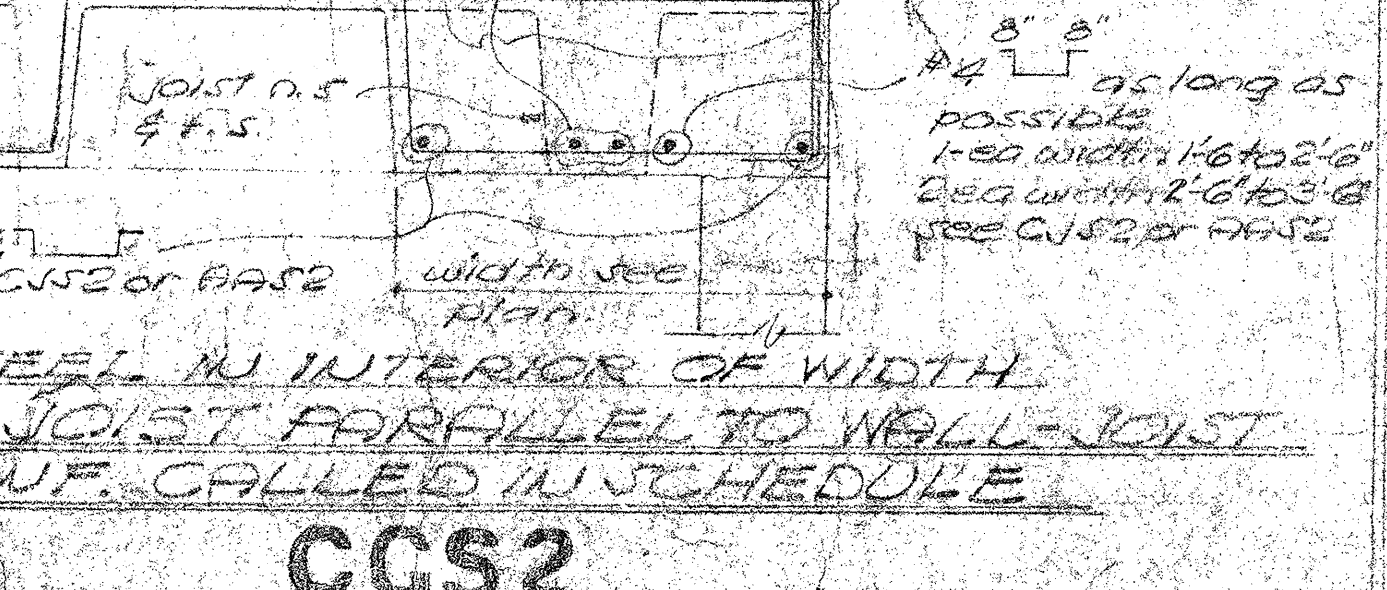

TYPICAL JOIST PARALLEL TO WALL. JOIST REINF. CALLED IN SCHEDULE
CFS2

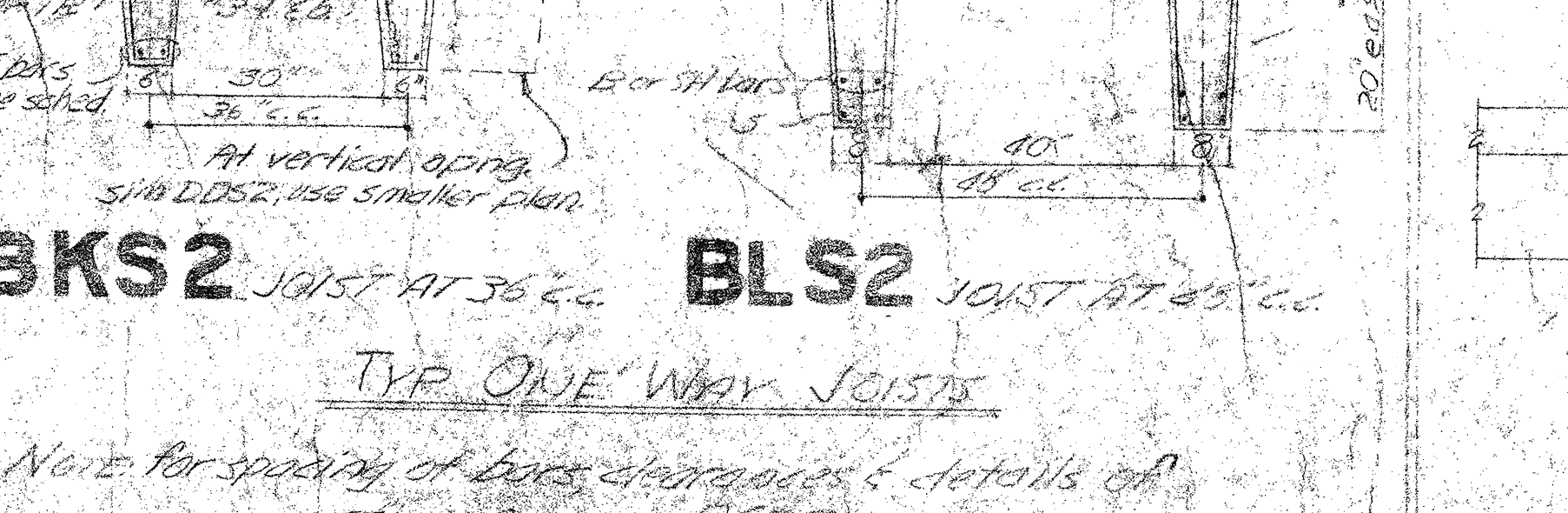

TYP. ONE WAY JOIST
BKS2



TYP. ONE WAY JOIST
AES2

TWO WAY WAFFLE SYSTEMS ONE WAY JOISTS SIMILAR

TYP. ONE WAY JOIST
BLS2

TYP. ONE WAY JOIST
BLS2

TYP. ONE WAY JOIST
AES2

TYP. ONE WAY JOIST
ADS2

JOHN CARL WARNECKE AND ASSOCIATES
ARCHITECTS AND PLANNING CONSULTANTS
61 NEW MONTGOMERY STREET
SAN FRANCISCO

ROBERT THOMPSON
ENGINEERS
MECH. & ELEC. ENGINEERS
CIVIL ENGINEERS

COLLEGE OF SAN MATEO
SAN BRUNO
CALIFORNIA

DISTRICT SET
SCALE AS NOTED
JOB NO. 194
D.B.
CHECK BY
DATE 11-1-71
NO. REVISION DESCRIPTION DATE APPROVED
SHEET NUMBER
92
OF 9 REVISED