



College of San Mateo
Exterior Signage Design Standards

Part 1

Introduction.....2
 Welcome.....3
 About This Sign System.....3
 Using This Manual.....4
 ADA & Code/Regulatory Signs.....4

Part 2

Graphic Standards.....5
 Fonts & Arrows.....6
 Colors.....7
 Pictograms.....8
 Line Spacing Hierarchy.....9
 Message Hierarchy Relationships.....10

PART 3

Mounting Details.....11
 Sign Components - Freestanding Signs 12
 Sign Components - Pole-Mounted 13
 Sign Components - Post-Mounted 14
 Street Sign Mounting 15

Part 4

Directional Signs.....16
 VD1 Vehicular Directional - Primary.....17
 VD2 Vehicular Directional - Secondary.....18
 VD3 Vehicular Directional - Tertiary.....19
 CD1 Campus Directional - Primary.....20
 CD2 Campus Directional - Street
 Identification.....21
 CD3 Campus Directional - Tertiary.....22

Part 5

Identification Signs.....23
 PID1 Parking Lot Name Identification -
 Primary.....24
 PID2 Parking Lot Name Identification -
 Secondary.....25
 PID3 Parking Lot Rules Identification.....26
 PID4 Parking Lot Name Identification - Post.....27
 PID5 Parking Lot Area Identification - Pole.....28

Part 5

Identification (Continued)

PID6 Parking Stall Identification - Pole.....29
 PID7 Parking Pay Station Identification30
 BID1 Building Identification - Window
 Graphics.....31
 BID2 Building Identification - Dimensional.....32

Part 6

Informational Signs.....33

PIN1 Parking Station Information.....34
 PIN2 Parking Information Hours.....35
 PIN3 Parking Information Hours Small.....36
 PIN4 Information Surveillance Notice.....37
 PIN5 Parking Information Motorcycle.....38
 PIN6 Parking Information Electric Vehicle.....39
 PIN7 Parking Information - Electric
 Vehicle Charging Time Limits.....40
 AFI.01 Athletic Field Information - Danger
 Stay Back.....41
 AFI.02 Athletic Field Information - Own Risk...42
 AFI.03 Athletic Field Information - Beware.....43

Part 7

Orientation Signs43

OR1 Campus Orientation.....44

Part 8

Regulatory Signs.....45

RG1 Regulatory Permit Parking.....46
 RG2 California Vehicle Code.....47
 RG3 Designated Parking.....48
 RG4 Smoking Prohibited.....49
 RG5 Smoking Prohibited Window Graphic.....50
 RG6 No Skateboarding.....51
 MUTCD Standard Regulatory Signs.....52
 AED Automatic External Defibrillator
 Window Decal.....53

Part 9

Specifications.....54

Part 1

Introduction

Welcome

About this Sign System

Using This Manual

ADA & Code /Regulatory Signs

Welcome

This Sign Standards program has been implemented for College of San Mateo to accomplish the following:

- *Help students, visitors, and emergency responders find their way around the campus with ease.*
- *Provides a unique sign program that supports both the new and existing architecture and works cohesively with college's branding.*
- *Reduce the time frame required to implement new signs as the campus evolves.*
- *Reduce the cost of design and implementation of new signs.*
- *Enhance the environment throughout the campus with a quality sign program.*

This document contains sign configurations that will effectively meet a range of sign functions and requirements. This standards manual contains the tools necessary to implement new signs ensuring consistency throughout the campus.

About This Sign System

When deciding to add new signs, there are three steps in the process. First, ensure the signs orient visitors from the point of entry. Second, ensure the visitors are easily directed to their destination. Third, provide college approved nomenclature for their destination. Along the way, the signs should communicate regulatory and general information. *This sign system is divided into five categories:*

- **DIRECTIONAL SIGNS**
Guide visitors from the point of entry
- **IDENTIFICATION SIGNS**
Identify parking lots and buildings
- **INFORMATIONAL SIGNS**
Display instructions, policies, hours of operation, etc
- **ORIENTATION SIGNS**
Inform visitors, staff, students and others of their location in relationship to the campus
- **REGULATORY SIGNS**
Inform required compliance with State and Federal codes as well as SMCCCD restrictions

Using This Manual

The Sign Standards Manual contains the information needed for ordering new signs. All fonts, colors, sign types, and mounting methods can be found within this document.

This sign system has been designed to promote the cohesive identity of College of San Mateo and their commitment to standardization and leveraged purchasing.

This Sign Standards Manual illustrates the available sign components, specifications, systems, and procedures for planning and ordering a complete exterior sign program.

The components contained in this manual are tools for providing wayfinding information to College of San Mateo staff, students, and visitors, while communicating the organization's identity and commitment to branding.

ADA & Code/Regulatory Signs

The Americans with Disabilities Act

The Americans with Disabilities Act (ADA) was signed into law on July 26, 1990, by President George H.W. Bush. The ADA is one of America's most comprehensive pieces of civil rights legislation that prohibits discrimination and guarantees that people with disabilities have the same opportunities as everyone else to participate in the mainstream of American life -- to enjoy employment opportunities, to purchase goods and services, and to participate in State and local government programs and services. *"Introduction to the ADA." Informational and Technical Assistance on the Americans with Disabilities Act. N.p., n.d. Web. 7 May 2015. <http://www.ada.gov/ada_intro.htm>.*

California Access Compliance Reference Materials

The Division of the State Architect (DSA) promulgates California Building Code (CBC) provisions to address accessibility for persons with disabilities. These provisions are applicable to State and local government buildings and facilities, public accommodations and commercial facilities, and public housing.

The accessibility provisions of the 2013 CBC have been revised and reformatted to conform to the requirements of the 2010 Americans with Disabilities Act (ADA) Standards for Accessible Design and maintain enhanced California accessibility provisions from the previous building code. The 2013 CBC is effective as of January 1, 2014. *"DSA's California Access Compliance Reference Materials." California Department of General Services. N.p., 2014. Web. 7 May 2015. <<http://dgs.ca.gov/dsa/Programs/progAccess/accessmanual.aspx>>.*

Note: The ADA and the California Building Code are evolving pieces of legislation. This Sign Standards Package complies with these laws as of the printing date of this manual. As new laws are enacted and existing ones revised, this system will be modified to comply. Included in the manual are a variety of signs governed by state, federal or local agencies. It is the sign specifier's responsibility to determine which signs are applicable to any specific circumstances based on current laws and regulations.

Part 2

Graphic Standards

Fonts & Arrows

Colors

Pictograms

Line Spacing Hierarchy

Message Hierarchy Relationships

Fonts

Humanst521 BT : Text

A B C D E F G H I J K L M N O P Q R S T U V W X Y Z
a b c d e f g h i j k l m n o p q r s t u v w x y z

Humanst521 BT Bold: Text

A B C D E F G H I J K L M N O P Q R S T U V W X Y Z
a b c d e f g h i j k l m n o p q r s t u v w x y z

Lucida Sans Demibold : Numbers

1 2 3 4 5 6 7 8 9 0

Arrows



Colors

P1



CSM Dark Blue
PMS 280
Matthews Paint :
MP00346

P2



CSM Medium Blue
PMS 2925
Matthews Paint :
MP00909

P3



CSM Light Blue
PMS 2915
Matthews Paint :
MP00908

P4



Sparkle Silver
Paint for Poles
Matthews Paint :
SV-952 SP

P5



Scott Bronze Metallic
Paint for Dimensional Letters
MP40366

P6



Bone
Paint for Dimensional Letters
Kelly Moore : OW27

V1



White Opaque Vinyl
3M Scotchcal Vinyl Film
Matte White 7125-20

V2



White Reflective Vinyl
3M Scotchlite Reflective
White 680-10

V3



Red Opaque Vinyl
3M Scotchcal Vinyl Film
Tomato Red 7725-13
PMS 1795C

Pictograms

Sign Types : PLI1 and PLI2 / As of March 2010



Beethoven



Stadium



Sand Box



Forum



Bulldog



Hillsdale



Galileo



DaVinci



Marie Currie



Olympian



Edison

Sign Types : R4 and R5.1



No Skateboarding



**Surveillance
Warning**



**Motorcycle
Parking**



**Electric Vehicle
Charging Station**



**International
Symbol of
Accessibility**



**Universal No
Smoking**



**Designated
Smoking Area**

Line Spacing Hierarchy

The line spacing hierarchy shown below is a guide for laying out copy on exterior wayfinding signage. This example should be used for laying out new message groupings that are not already detailed in this catalog. For existing directional sign types layouts, please refer to Part 4 of this catalog for layout dimensions.



Message Hierarchy Relationships

This Section defines a uniform hierarchy of messages and information to be used throughout the Skyline College Campus. Using the guidelines and terminology outlined in this manual, the messages shall be organized into three succinct categories: Primary, Secondary, and Tertiary.

Entries shall be grouped by direction and listed in alphabetical order.

Messages should be compiled by direction: Ahead, Left, and Right. Ahead destinations should be the first listing. If there is no destination ahead, the left turn destinations should be listed first, then right turn destinations. Each directional listing is to be in alphabetical order.

Messages should also be compiled in relation to the location of the directional sign. The farther out the directional sign is from the campus center, the broader the nomenclature should be, such as "Athletic Fields", "Main Campus" or "Parking". More specific terms or building names should be used as you move closer to the destination, such as "Parking Lot A", "Building 1" or "Cosmetology".

All directional messages, along with all signage programming, should be reviewed and approved by the Vice Chancellor of Facilities prior to fabrication.

Part 3

Mounting Details

Sign Components – Freestanding Signs

Sign Components – Pole-Mounted Signs

Sign Components – Post-Mounted Signs

Sign Components – Street Signs

**Mounting Details
Sign Components - Freestanding Signs**

SignComp™
 3032 Walker Ridge Drive, NW
 Grand Rapids, MI 49544
 616.784.0405 / 877.784.0405
 www.signcomp.com

SignComp Part Numbers

- A. Large Scale Signs**
- Post :** Series 3, 1210
- Reveal :** Series 3, 1200
- Frameless Body:** Series 2, 1125

This detail is intended for larger signs. Use
 with Sign Types:
 VD1
 VD2
 VD3
 CD1
 OR1

- B. Small Scale Signs**
- Post :** Series 3, 1210
- Reveal :** Series 3, 1202

This detail is intended for
 smaller signs. Use with Sign Types:
 TBD

A. Large Scale Signs

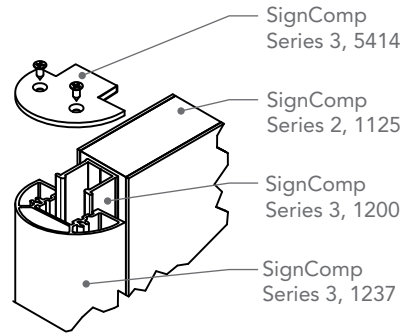
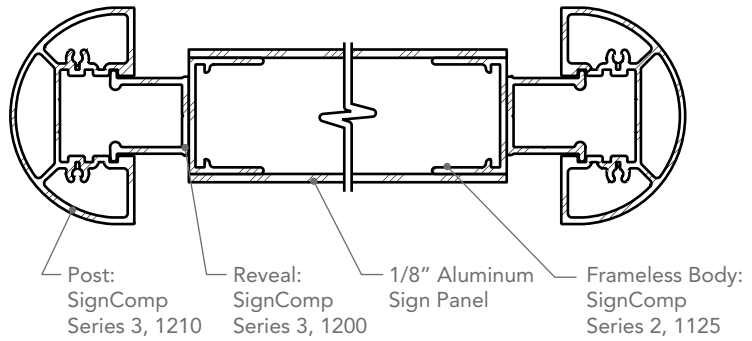

B. Small Scale Signs

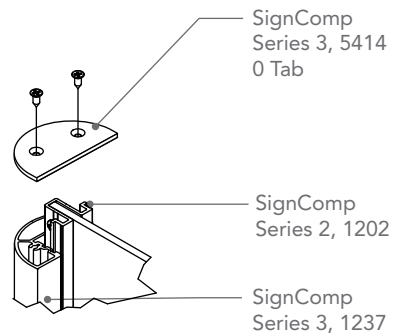
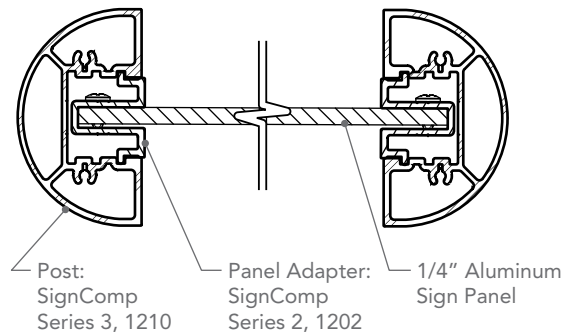

Mounting Details
Sign Components - Pole-Mounted

C. Custom Fabrication

Detail for Light
 Standard Attachment

Use this detail for the
 following sign types:

PID4

PID5

Note: Manufacturer to structure
 and detail exact attachment to
 light standard.

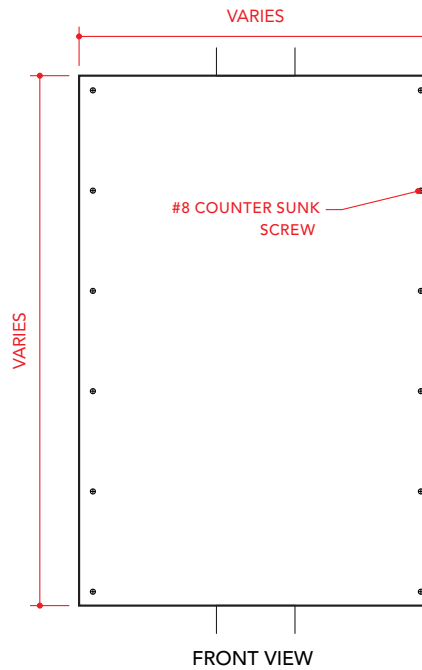
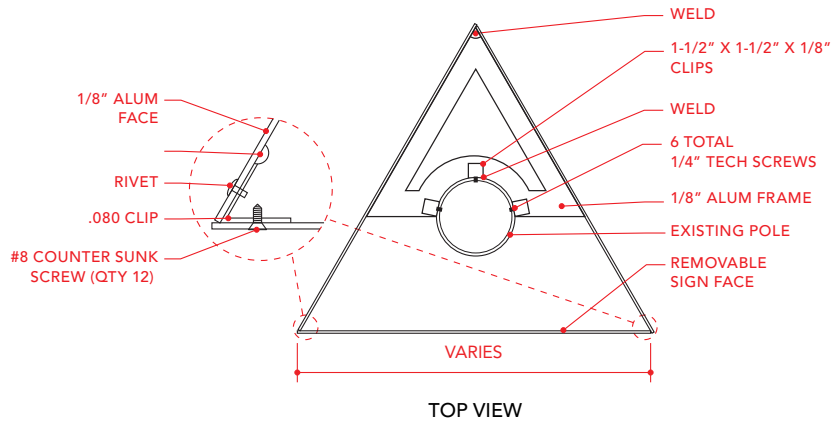

Mounting Details

Sign Components - Post-Mounted

Hawkins Traffic Safety Supply

1255 Eastshore Highway
Berkeley, CA 94710
800-772-3995
<http://www.hawkinstrafficsupply.com>

D. Sign Mounting Bracket

Post : 2.5" Galvanized

Bracket with Vandal Nut: M2G-C2.5SPB-VPN
or

Bracket with Cap Screw: M2G-C2.5SPB-TP

This detail is intended for larger signs. Use with
Sign Types:

PID1
PIN2
PIN3
PIN4
PIN5
PIN7
RG1
RG2
RG3
RG4
PID6
PID7

And any signs that require mounting to a post,
such as: Stop signs; Do Not Enter signs; Parking
Regulation signs; Speed Limit signs.

Roadway regulatory signs can also be ordered from
Hawkins Traffic Safety Supply.

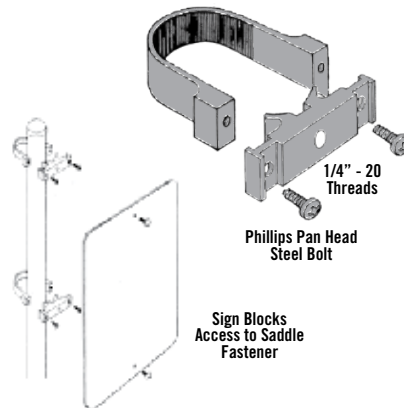

THEFT PROOF CAP SCREW

Steel and Zinc Head
Cap Screw
5/16" - 18 x 1/2"
with Nylon Washer

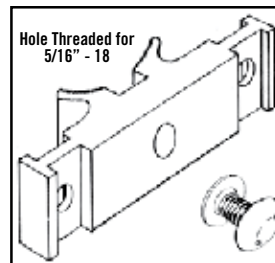

BOLT WITH VANDAL CAP NUT

Vandal Proof Zinc Head
5/16" - 18 x 1"
with Standard Steel
Hex Head Bolt

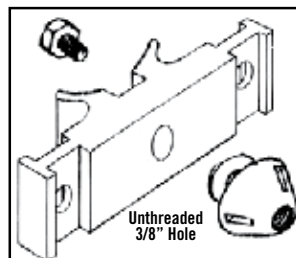

10 14 00 Exterior Signage - College of San Mateo

Street Sign Mounting

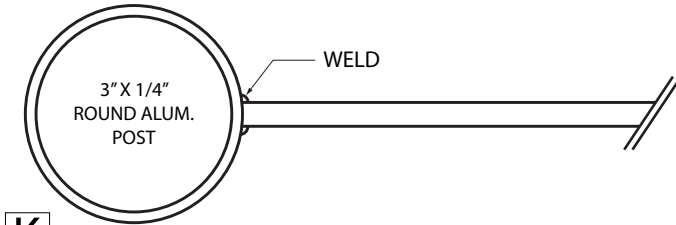

K

Detail : For 1, 2, 3, and 4 blades

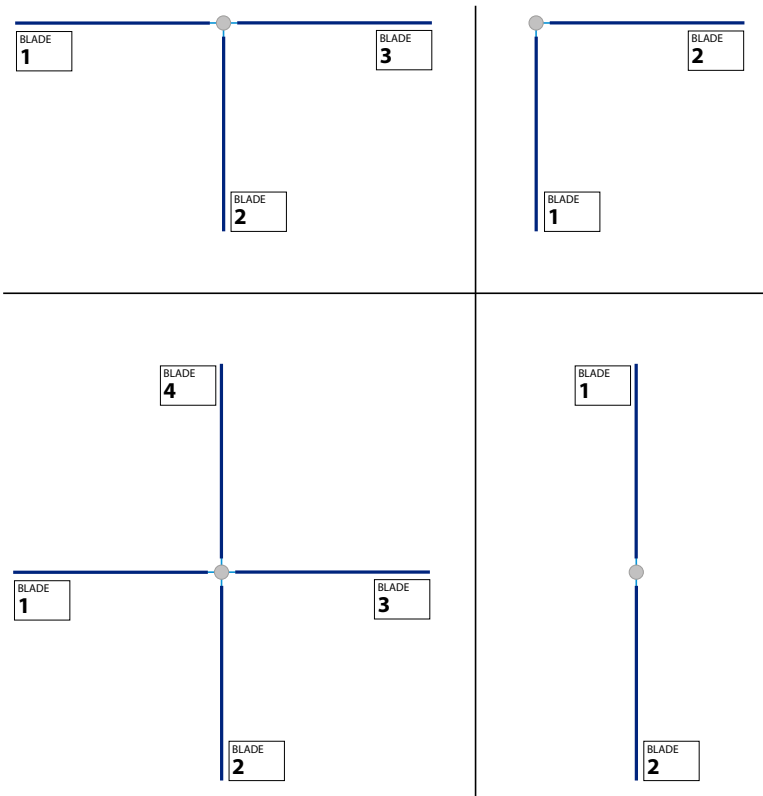

Part 4

Directional Signs

VD1 Vehicular Directional - Primary

VD2 Vehicular Directional - Secondary

VD3 Vehicular Directional - Tertiary

CD1 Campus Directional - Primary

CD2 Campus Directional - Street ID

CD3 Campus Directional - Tertiary

SIGN TYPE: VD1
Vehicular Directional - Primary

This sign type is to be used for directing vehicles to major destinations around the campus. This sign is to be placed perpendicularly to the roadway, facing on-coming traffic, no less than 18" from the curb. Sign is to be located in landscaped areas, not on pedestrian walkways or driveways. Messages are to be limited to primary buildings and parking lots grouped by direction, and listed in alphabetical order.

Colors: P1, P2, P4*

Exposed Edges: Paint colors to wrap edges

Sign Back: If sign is not double-sided, then header to be painted P1, lower portion to be painted P2 as shown, while applying monogram with P3

Font: Humanst521 BT

Letter Height

All Text: 5 1/2"

Arrows: 7 1/2" x 7 1/2"

Graphics Material: V2

Post & Panel Information: See Page 12

*Use Monogram Logo when no text is present on Vehicle Wayfinding signs only.

Note: Structural requirements to be determined by a licensed structural engineer.

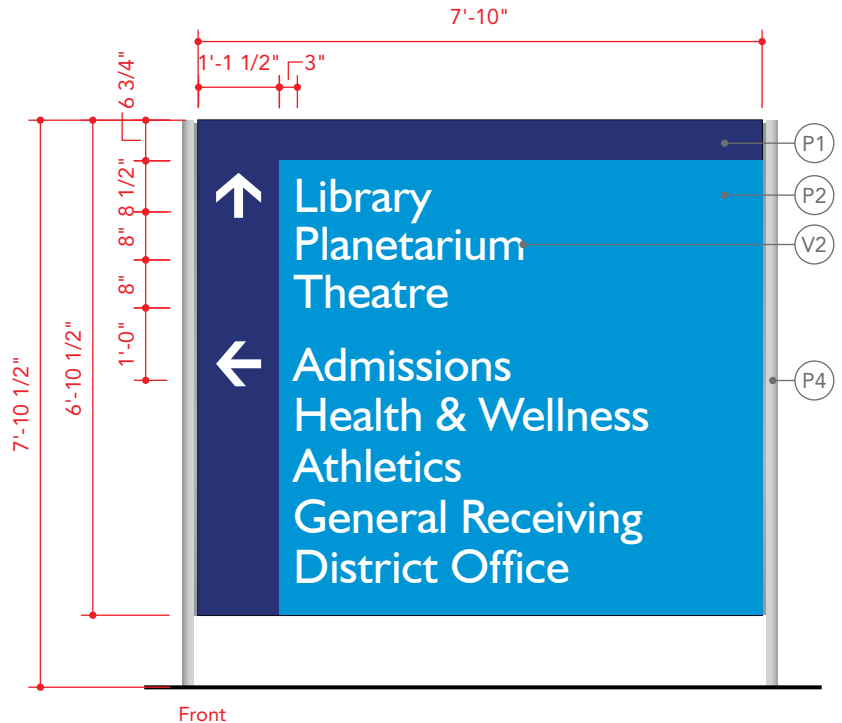

Back
 Scale: 3/8" = 1'-0"

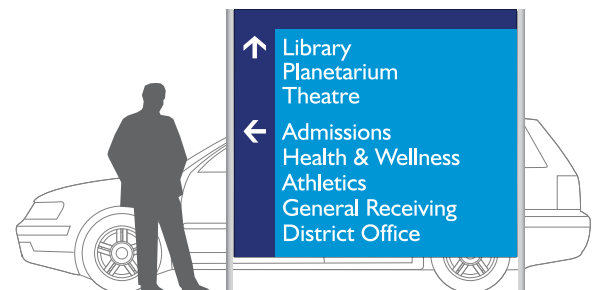

SIGN TYPE: VD2

Vehicular Directional - Secondary

This sign type is to be used for directing vehicles to secondary destinations within the campus. This sign is to be placed perpendicularly to the internal roadways and parking lots, facing on-coming traffic, no less than 18" from the curb. Sign is to be located in landscaped areas, not on pedestrian walkways or driveways. Messages are to be limited to primary buildings and parking lots, and listed in alphabetical order by direction.

Colors: P1, P2, P3*

Exposed Edges: Painted P2, P3

Sign Back: If sign is not double-sided, then header to be painted P1, lower portion to be painted P2 as shown, while applying monogram with P3

Font: Humanst521 BT

Letter Height

All Text: 3"

Arrows: 5" x 5"

Graphics Material: V2

Post & Panel Information: See Page 12

*Use Monogram Logo when no text is present on Vehicle Wayfinding signs only.

Note: Structural requirements to be determined by a licensed structural engineer.

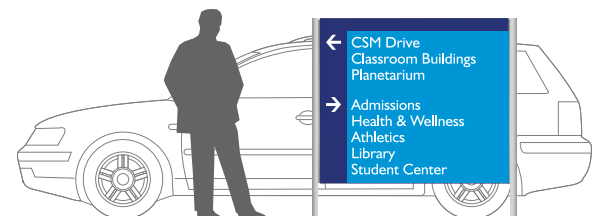
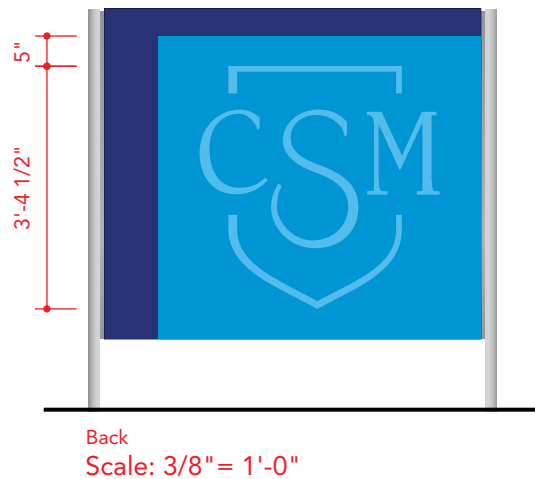
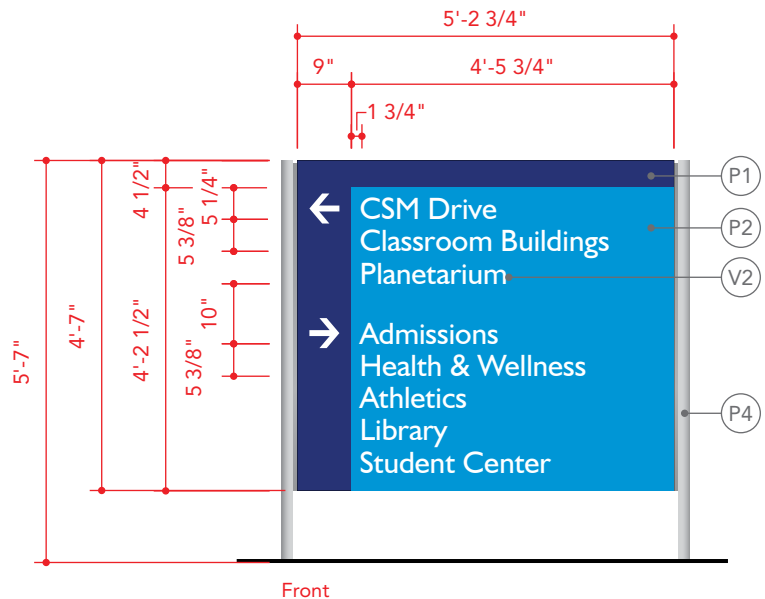

SIGN TYPE: VD3

Vehicular Directional - Tertiary

This sign type is to be used for directing vehicles to minor destinations around the campus. This sign is to be placed perpendicularly to the roadway, facing on-coming traffic, no less than 18" from the curb.

Sign is to be located in landscaped areas, not on pedestrian walkways or driveways. Messages are to be limited to secondary and tertiary destinations, and parking lots grouped by direction and listed in alphabetical order.

Colors: P1, P2, P4*

Exposed Edges: Paint colors to wrap edges

Sign Back: If sign is not double-sided, then header to be painted P1, lower portion to be painted P2 as shown, while applying monogram with P3

Font: Humanst521 BT

Letter Height

All Text: 3"

Arrows: 5" x 5"

Graphics Material: V2

Post & Panel Information: See Page 12

*Use Monogram Logo when no text is present on Vehicle Wayfinding signs only.

Note: Structural requirements to be determined by a licensed structural engineer.

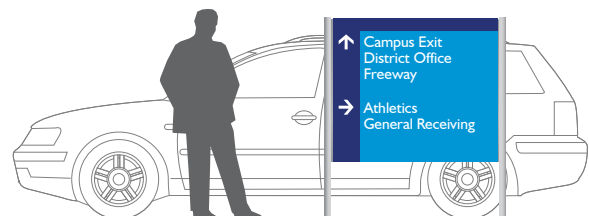
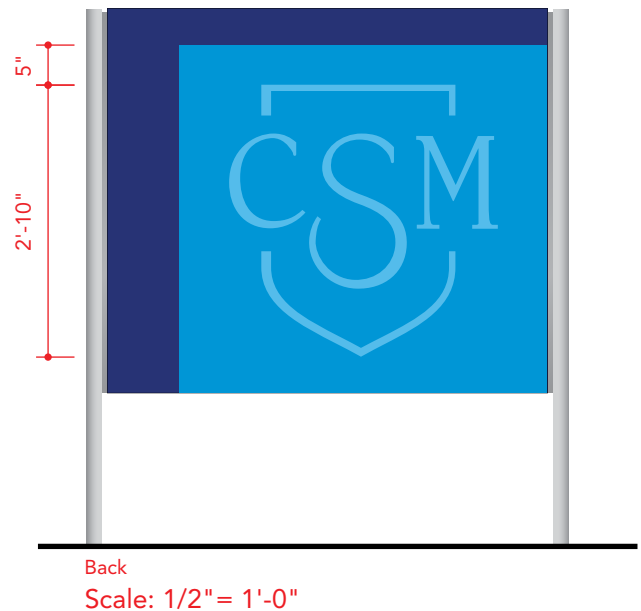
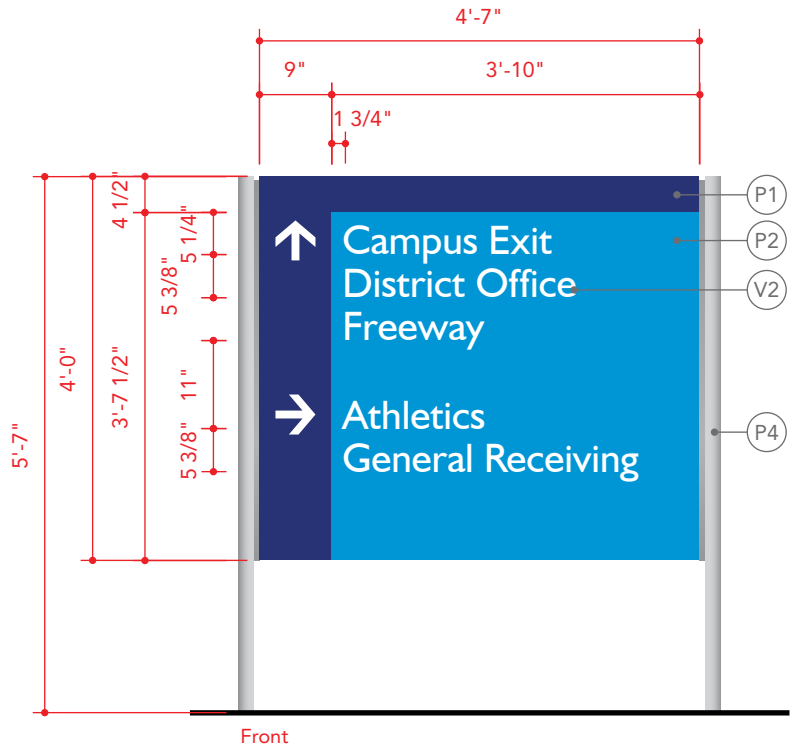

SIGN TYPE: CD1
Campus Directional - Primary

This sign type is to be used for directing pedestrians to major destinations within the campus. This sign is to be placed perpendicularly to the walkway, facing on-coming pedestrians, no less than 18" from the walkway. Sign is to be located in landscaped areas, not on pedestrian walkways. Messages are to be limited to primary buildings and parking lots grouped by direction, and listed in alphabetical order.

Colors: P1, P2, P4*

Exposed Edges: Paint colors to wrap edges

Sign Back: If sign is not double-sided, then header to be painted P1, lower portion to be painted P2 as shown, while applying monogram with P3

Font: Humanst521 BT

Letter Height

All Text: 2 1/4"

Arrows: 3 1/2" x 3 1/2"

Graphics Material: V2

Post & Panel Information: See Page 12

*Use Monogram Logo when no text is present on Vehicle Wayfinding signs only.

Note: Structural requirements to be determined by a licensed structural engineer.

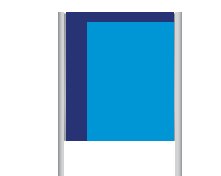
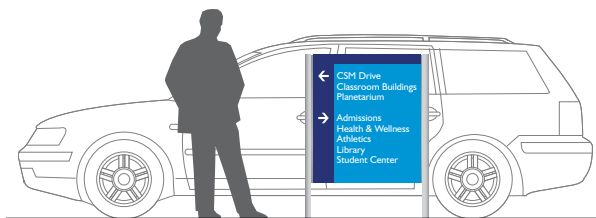
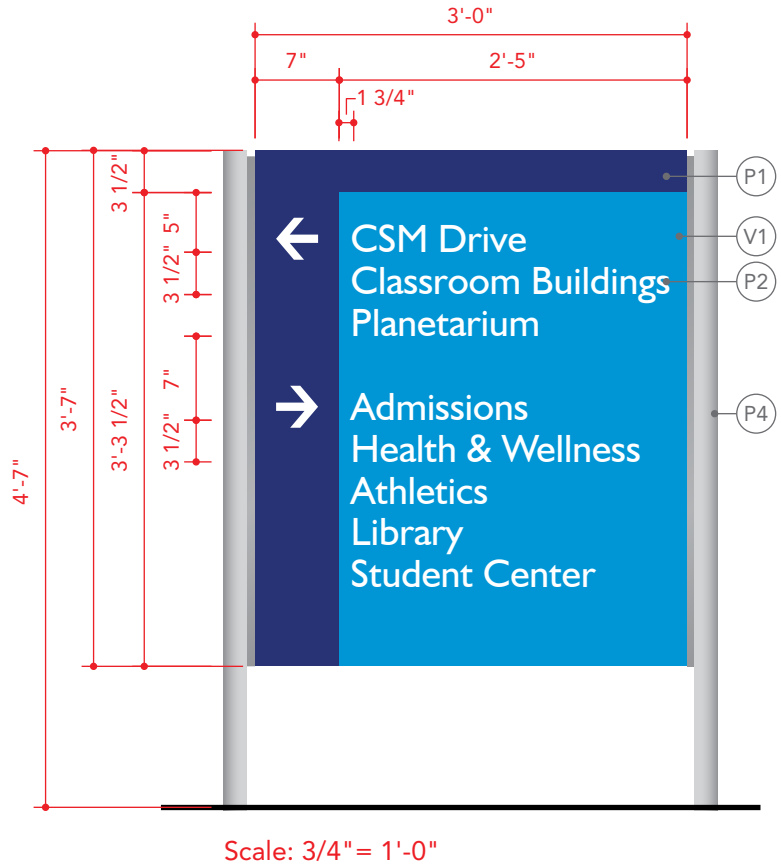

Back View

SIGN TYPE: CD2

Campus Directional - Street Identification

This sign type is to be used for identifying streets within the campus. This sign is to be placed perpendicularly to the street, facing on-coming traffic, no less than 18' from the street. Sign is to be located in landscaped areas, not on pedestrian street. Messages are to be limited to buildings and parking lots.

Front Colors: P1, P2

Sign Thickness: 1/4" aluminum panel

Exposed Edges: Paint colors to wrap edges

Sign Back: P1, P2

Font: Humanst521 BT

Letter Height: 3.5"

Graphics Material: V2

Post Information: See Page 15

Note: Structural requirements to be determined by a licensed structural engineer.

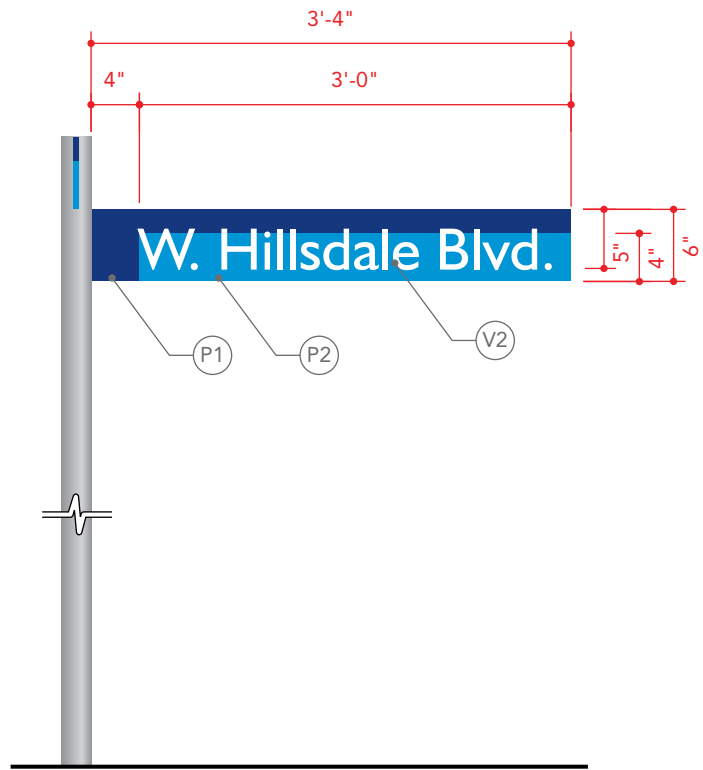

Scale: 3/4" = 1'-0"

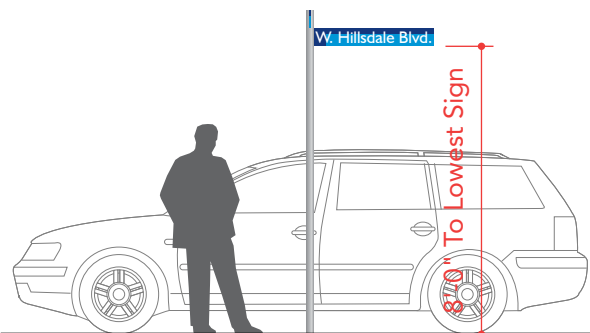

SIGN TYPE: CD3

Campus Directional - Tertiary

This sign type is to be used for directing pedestrians to secondary destinations within the campus. This sign is to be placed on walls, facing on-coming pedestrians. Messages are to be limited to buildings and parking lots.

Front Colors: P1, P2

Sign Thickness: 1/4" aluminum panel

Exposed Edges: Paint colors to wrap edges

Sign Back: P1, P2

Font: Humanst521 BT

Letter Height

All Text: 2 1/4"

Pictogram: 2 1/2"

Graphics Material: V1

Note: Structural requirements to be determined by a licensed structural engineer.

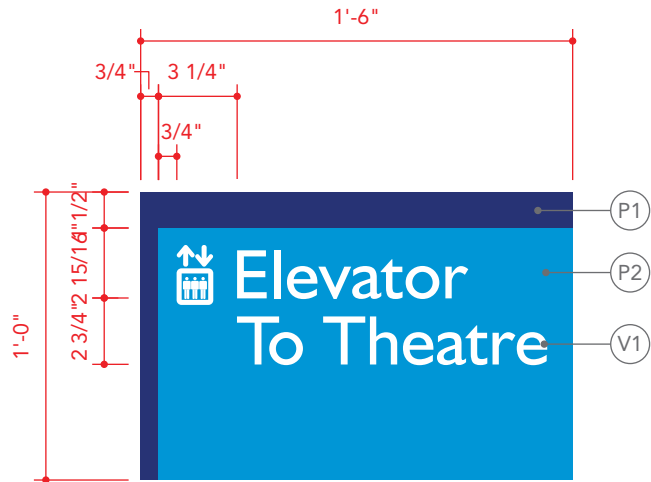

Scale: 1 1/2" = 1'-0"



Part 5

Identification Signs

PID1 Parking Lot Name Identification - Primary

PID2 Parking Lot Name Identification - Secondary

PID3 Parking Lot Rules Identification - Tertiary

PID4 Parking Lot Name Identification - Post

PID5 Parking Lot Area Identification - Pole

PID6 Parking Stall Identification - Pole

PID7 Parking Pay Station Identification

BID1 Building Identification - Window Graphics

BID2 Building Identification - Dimensional

SIGN TYPE: PID1

Parking Lot Name Identification - Primary

This sign type is to be used for identifying parking lots to visitors and staff. This sign is to be placed perpendicularly to the street, facing on-coming traffic, no less than 18' from the street. Sign is to be located in landscaped areas, not on pedestrian walkways or driveways. Messages are to be limited to parking lot name and type with permit information.

Front Colors: P1, P2, P3

Exposed Edges: Paint colors to wrap edges

Back Colors: P1, P2

Font: Humanst521 BT

Letter Height

Header: 5 1/2"

Text: 2 3/4"

Number: 8"

Graphics Material: V1

Post & Panel Information: See Page 12

Note: Structural requirements to be determined by a licensed structural engineer.

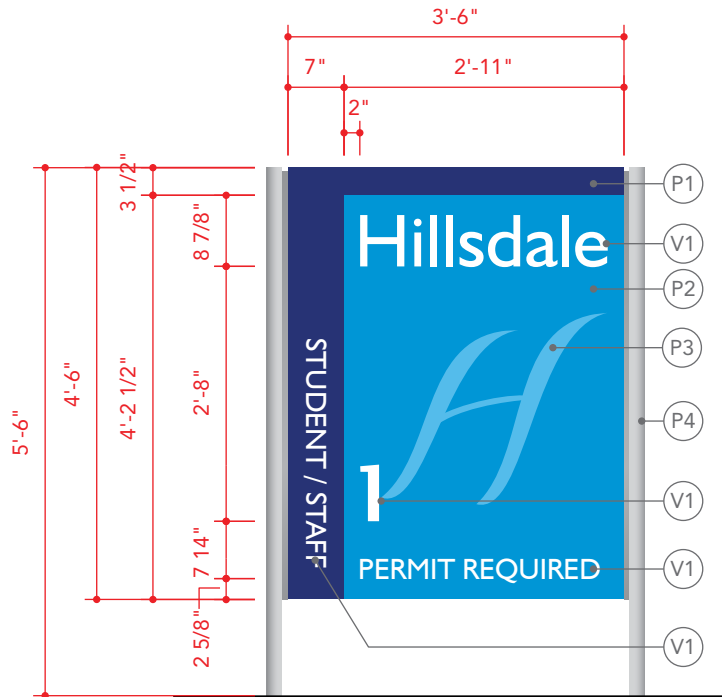

Scale: 1/2" = 1'-0"

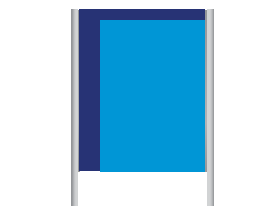

Back View

SIGN TYPE: PID2
Parking Lot Name Identification - Secondary

This sign type is to be used for identifying parking lots to visitors and staff. This sign is to be placed perpendicularly to the street, facing on-coming traffic, no less than 18" from the street. Sign is to be located in landscaped areas, not on pedestrian walkways or driveways. Messages are to be limited to parking lot name and type with permit information.

Front Colors: P1, P2, P3

Exposed Edges: Paint colors to wrap edges

Back Colors: P1, P2

Font: Humanst521 BT

Letter Height

Header: 5"

Text: 2 1/4"

Number:

Number: 7"

Font: Lucida Sans SemiBold

Graphics Material: V1

Post & Panel Information: See Page 12

Note: Structural requirements to be determined by a licensed structural engineer.

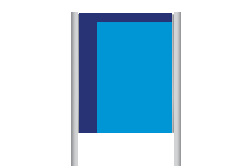
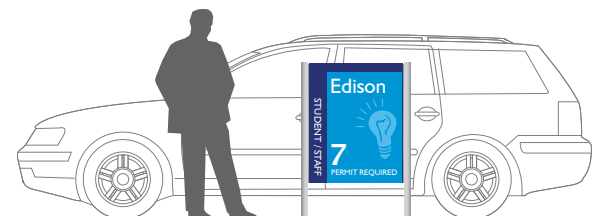
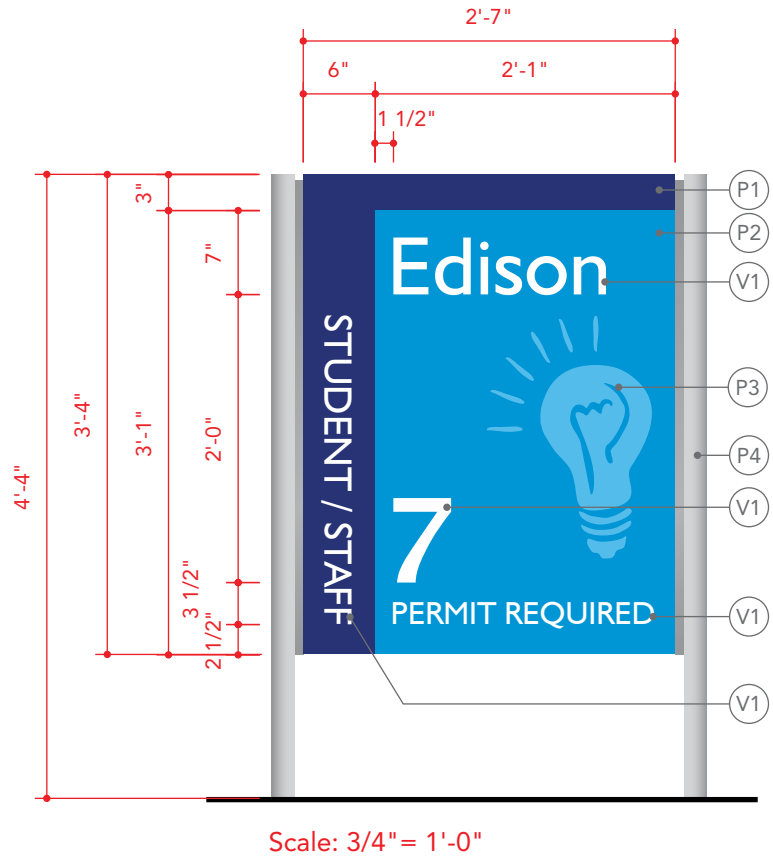

Back View

10 14 00 Exterior Signage - College of San Mateo

SIGN TYPE: PID3
Parking Lot Rules Identification

This sign type is to be used for identifying parking lots to visitors and staff. This sign is to be placed perpendicularly to the street, facing on-coming traffic, no less than 18" from the street. Sign is to be located in landscaped areas, not on pedestrian walkways or driveways. Messages are to be limited to parking lot name and type with permit information.

Front Colors: P1, P2, P3

Exposed Edges: Paint colors to wrap edges

Back Colors: P1, P2

Font: Humanst521 BT, Humanst521 BT Bold

Letter Height

Line 1: 2" - Bold

Lines 2-5 : 1 1/2" - Bold

Lines 6-9: 1 1/4"

Line 10: 1 1/2" - Bold

Graphics Material: V2

Watermark: Should take up about 30% of entire sign.

Post & Panel Information: See Page 12

Note: Structural requirements to be determined by a licensed structural engineer.

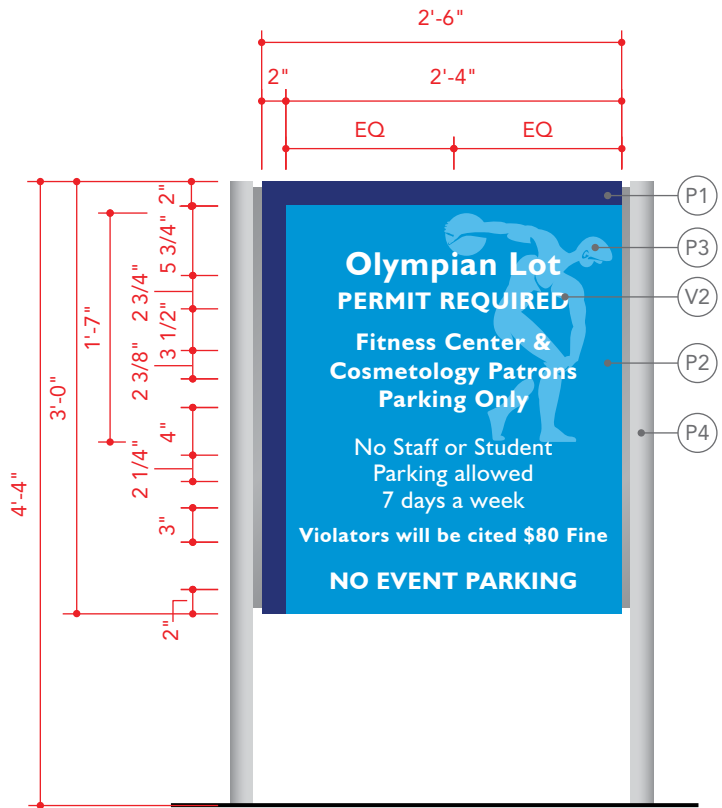

Scale: 3/4" = 1'-0"

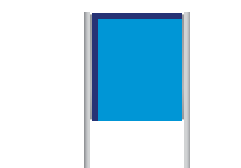

Back View

SIGN TYPE: PID4

Parking Lot Name Identification - Pole

This sign type is to be used for identifying parking lots to visitors and staff. This sign is to be placed on poles and light standards to inform which parking lot you are in. Sign to be mounted no lower than 15'-0" to the bottom of the sign.

Front Colors: P1, P2, P3

Sign Thickness: 1/4" aluminum panel

Exposed Edges: Paint colors to wrap edges

Sides: 3

Sign Quantity per Pole: 1 complete sign with 3 faces, all faces are the same

Fonts:

Text: Humanst521 BT

Number: Lucida Sans Demibold

Letter Height: 12"

Graphics Material: V1

Mounting Information: See Page 13

Note: Structural requirements to be determined by a licensed structural engineer.

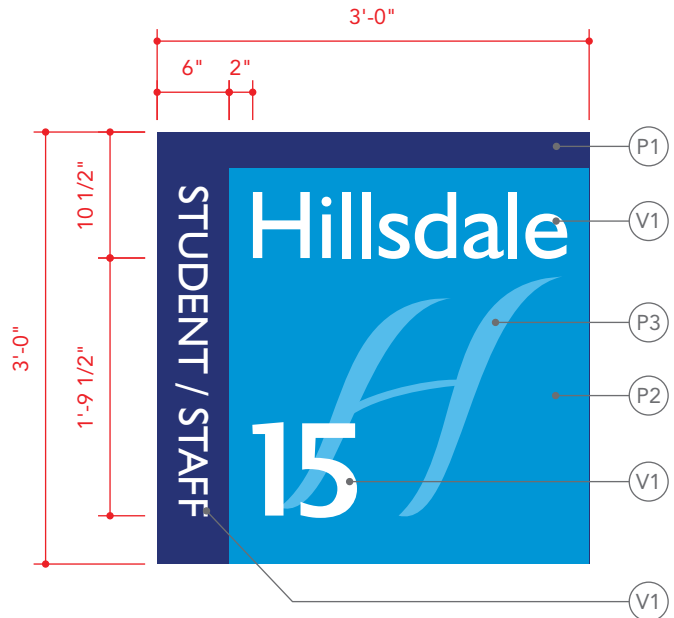

Scale: 3/4" = 1'-0"

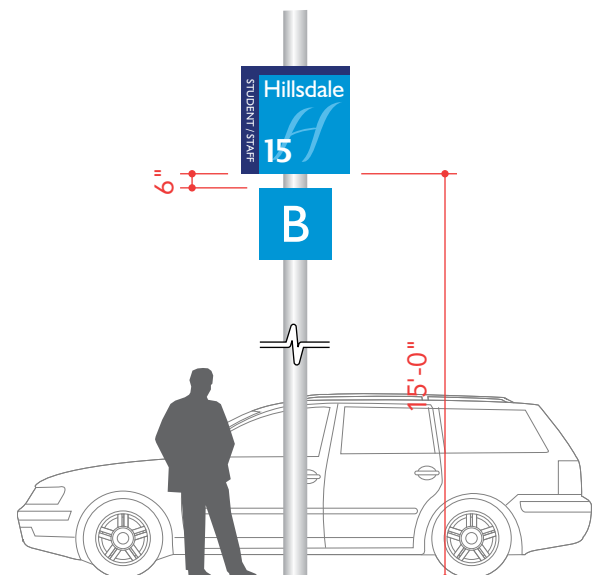

SIGN TYPE: PID5

Parking Lot Area Identification - Pole

This sign type is to be used for identifying parking lots to visitors and staff. This sign is to be placed on poles and light standards to inform which parking lot you are in. Sign to be mounted no lower than 12'-64" to the bottom of the sign.

Front Colors: P1, P2, P3

Sign Thickness: 1/4" aluminum panel

Exposed Edges: Paint colors to wrap edges

Sides: 3

Sign Quantity per Pole: 1 complete sign with 3 faces, all faces are the same

Font: Humanst521 BT

Letter Height: 12"

Graphics Material: V1

Mounting Information: See Page 13

Note: Structural requirements to be determined by a licensed structural engineer.

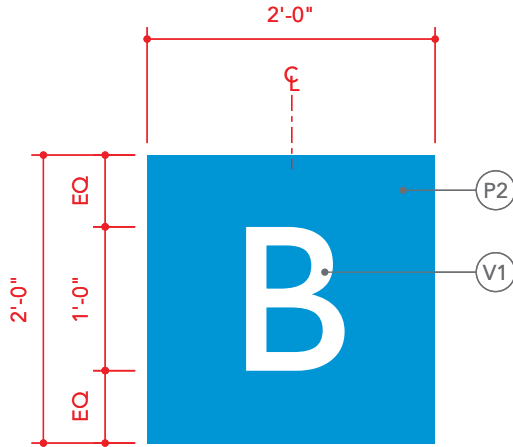

Scale: 3/4" = 1'-0"

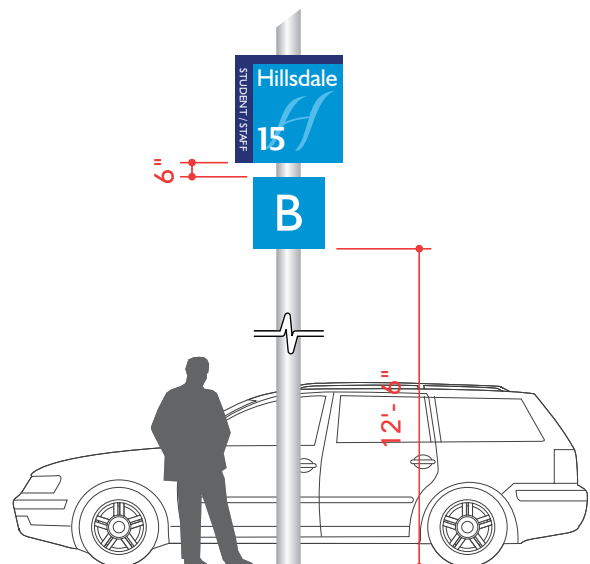

SIGN TYPE: PID6

Parking Staff Identification - Pole

This sign type is to be used for identifying parking lots to visitors and staff. This sign is to be placed on poles and light standards to inform which parking lot you are in. Sign to be mounted no lower than 7'-0" to the bottom of the sign.

Front Colors: P1, P2

Sign Thickness: 1/4" aluminum panel

Exposed Edges: Paint colors to wrap edges

Sign Back: P2

Font: Humanst521 BT Bold

Letter Height: 3"

Graphics Material: V1

Post Information: See Page 14

Note: Structural requirements to be determined by a licensed structural engineer.

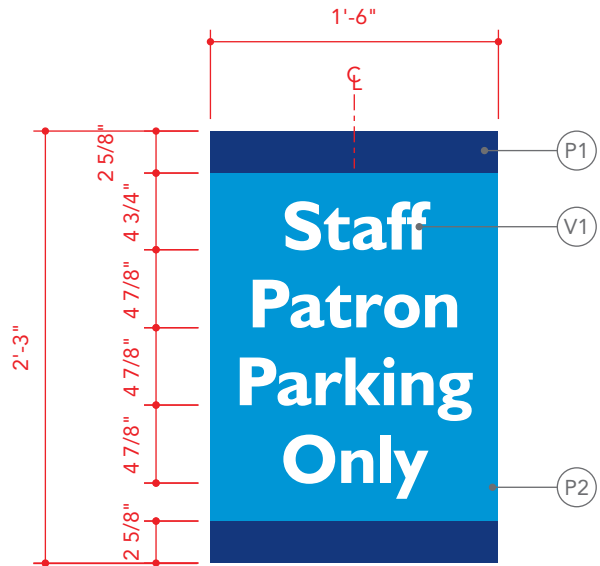

Scale: 1" = 1'-0"

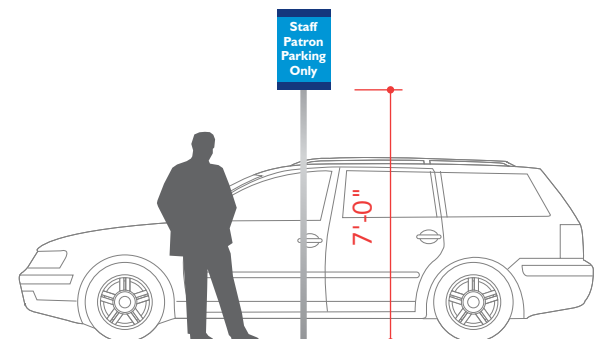

Back View

SIGN TYPE: PID7
Parking Pay Station Identification

This sign type is to be used for identifying parking lots to visitors and staff. This sign is to be placed on poles and light standards to inform which parking lot you are in. Sign to be mounted no lower than 15'-0" to the bottom of the sign.

- Front Colors:** P1, P2
- Sign Thickness:** 1/4" aluminum panel
- Exposed Edges:** Paint colors to wrap edges
- Sign Back:** P2

- Font:** Humanst521 BT Bold
- Letter Height**
- Lines 1-3: 3 1/2"
- Arrow: 10"
- Graphics Material:** V1

Post Information: See Page 14

Note: Structural requirements to be determined by a licensed structural engineer.

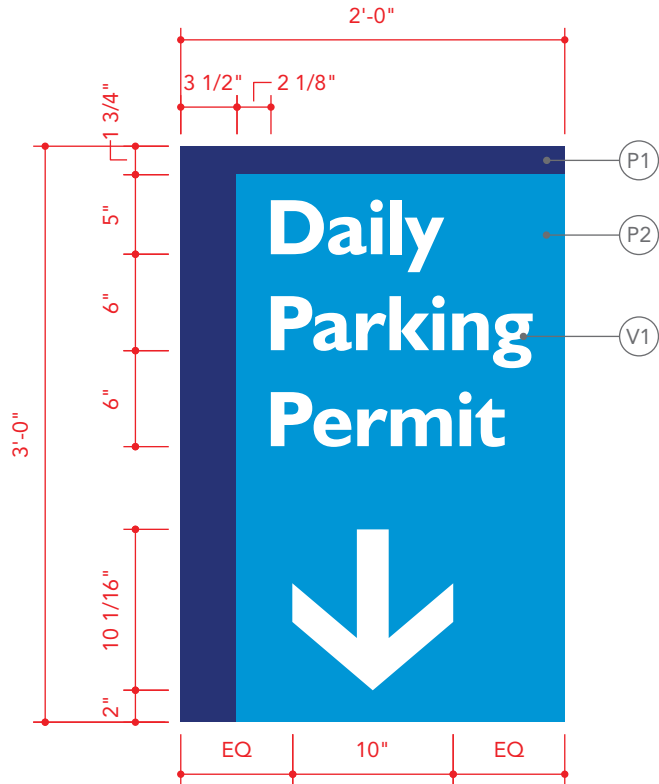

Scale: 1" = 1'-0"

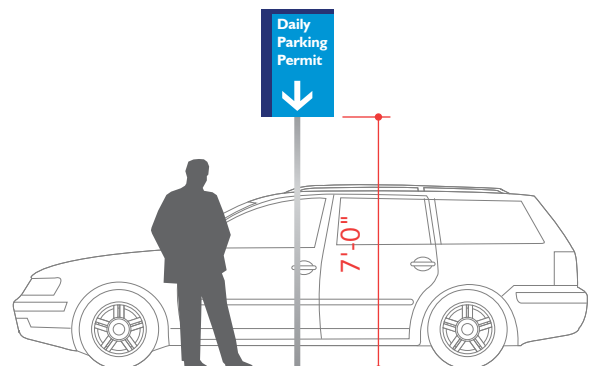

Back View

SIGN TYPE: BID1

Building Identification - Window Graphics

This sign type is used to identify buildings to visitors and staff. These signs are to be placed on the glass sidelight at building entrances to identify departments and spaces within the building. If no room on the glass sidelight, then sign should be placed on glass door following the same dimensions. All listings should be in alphabetical order. Building number, as shown below, to be centered on the glass transom window. If not able to center number on transom, place sign as close to center as possible or centered at the top of the door. All window graphics are to be placed on the first surface of the glass.

Font(s):

Number: Lucida Sans Demibold
 Text: Humanst521 BT Bold (header)
 Humanst521 BT (sub-text)

Letter Height:

Number: 6"
 Header: 3 1/2"
 Sub-text: 1 3/4"

Graphic Material: V1

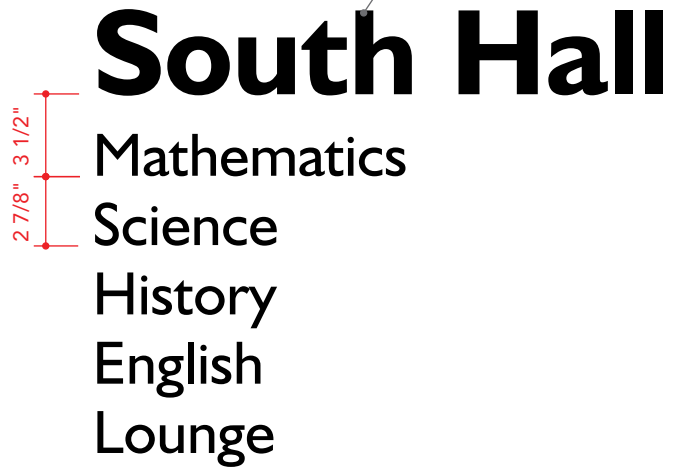
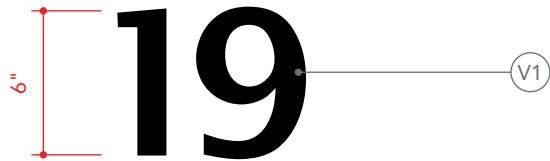

Scale: 1 1/2" = 1'-0"



Scale: 1/4" = 1'-0"

SIGN TYPE: BID2

Building Identification - Dimensional Graphics

This sign type is used to identify buildings to visitors and staff. These signs are to be placed on the building or wall facing on-coming vehicular or pedestrian traffic.

Font(s):

Numbers: Lucida Sans Demibold

Text: Humanst521 BT

Letter Height:

Numbers: 8"

Letters: 6"

Depth: 1"

Graphic Material: Aluminum

Color: P5 or P6



Dimensional Graphics
Numbers : Lucida Sans Demibold



Dimensional Graphics
Numbers : Lucida Sans Demibold
Letter A : Humanst521 Roman

Part 6

Informational Signs

PIN1 Parking Station Information

PIN2 Parking Information Hours

PIN3 Parking Information Hours Small

PIN4 Information Surveillance Notice

PIN5 Parking Information Motorcycle

PIN6 Parking Information Electric Vehicle

PIN7 Parking Information - Electric Vehicle Charging Time Limits

AFI.01 Athletic Field Information - Danger Stay Back

AFI.02 Athletic Field Information - Own Risk

AFI.03 Athletic Field Information - Beware

SIGN TYPE: PIN1

Parking Pay Station Instructions

This sign type is to be used to provide information on how to use the parking pay station. This sign is to be placed adjacent to the parking pay station within 12". Sign can also be mounted to a post or light standard with the bottom of the sign no lower than 7'-0".

Front Colors: P1, P2

Sign Thickness: 1/4" aluminum panel

Exposed Edges: Paint colors to wrap edges

Sign Back: P2

Font: Humanst521 BT, Humanst521 BT Bold

Letter Height

Lines 1-2: 1 1/2" - Bold

Lines 3-4: 1 1/2" - Regular

Lines 5-8: 1 1/4" - Regular

Lines 9-11: 1" - Bold

Graphics Material: V1

Post Information: See Page 14

Note: Structural requirements to be determined by a licensed structural engineer.

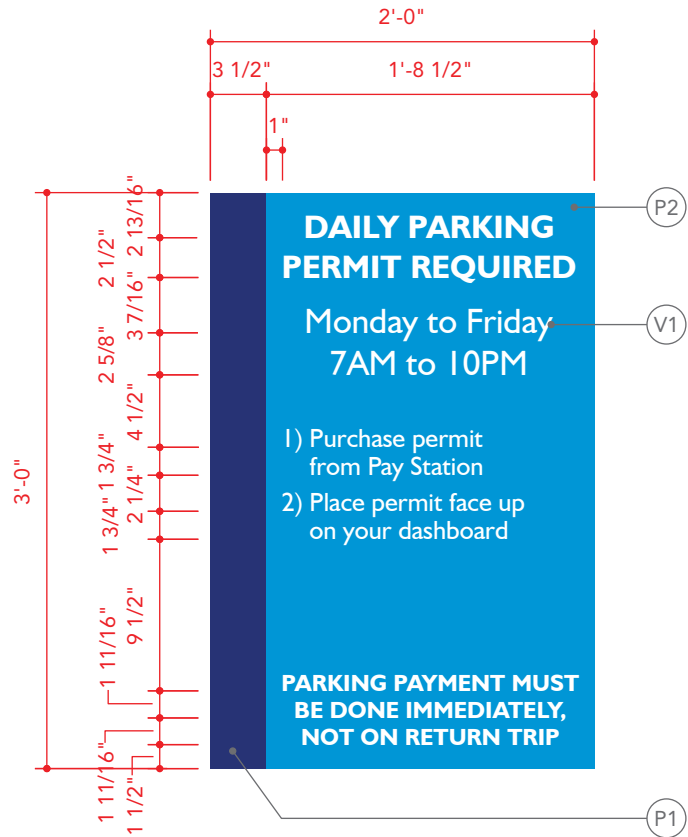

Scale: 1" = 1'-0"

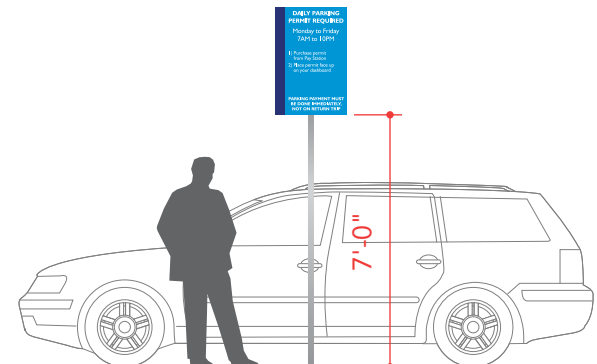

Back View

SIGN TYPE: PIN2

Parking Information - Hours Large

This sign type is to be used for identifying restricted parking areas around the campus. This sign is to be placed on poles at parking lot entrance perpendicular to oncoming traffic. Sign to be mounted no lower than 7'-0" to the bottom of the sign.

Front Colors: P1, P2

Sign Thickness: 1/4" aluminum panel

Exposed Edges: Paint colors to wrap edges

Sign Back: P2

Font: Humanst521 BT, Humanst521 BT Bold

Letter Height

Header: 2 1/2"

Lines 1-8: 1 3/4"

Graphics Material: V1

Post Information: See Page 14

Note: Structural requirements to be determined by a licensed structural engineer.

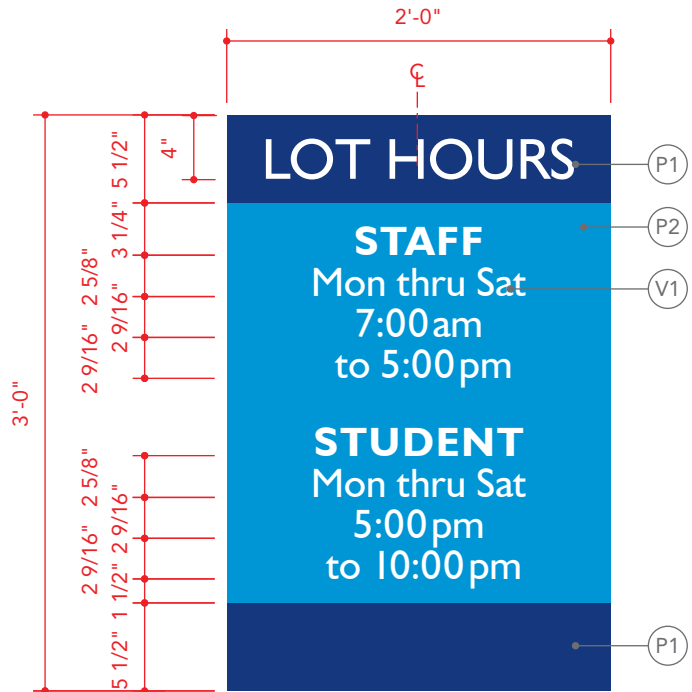

Scale: 1" = 1'-0"

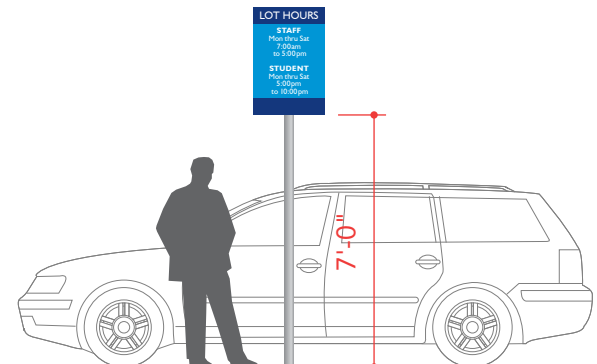

Back View

10 14 00 Exterior Signage - College of San Mateo

SIGN TYPE: PIN3

Parking Information - Hours Small

This sign type is to be used for identifying restricted parking areas around the campus. This sign is to be placed on poles at parking lot entrance perpendicular to oncoming traffic. Sign to be mounted no lower than 7'-0" to the bottom of the sign.

Front Colors: P1, P2

Sign Thickness: 1/4" aluminum panel

Exposed Edges: Paint colors to wrap edges

Sign Back: P2

Font: Humanst521 BT, Humanst521 BT Bold

Letter Height

Header: 2 1/2"

Lines 1-4: 1 3/4"

Graphics Material: V1

Post Information: See Page 14

Note: Structural requirements to be determined by a licensed structural engineer.

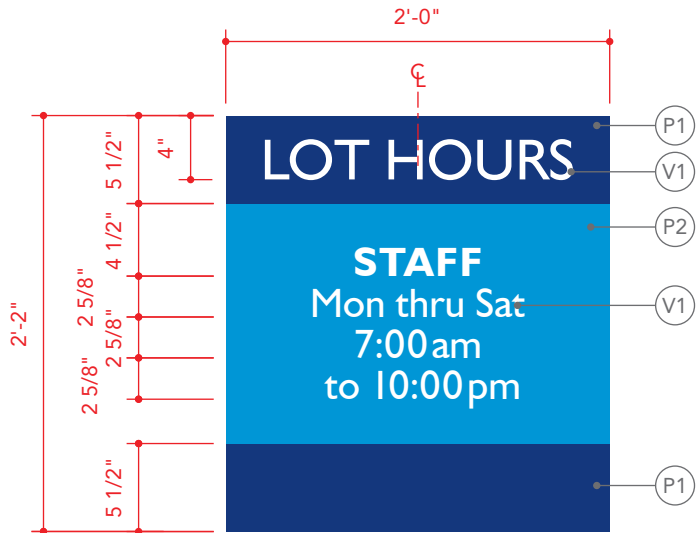

Scale: 1" = 1'-0"

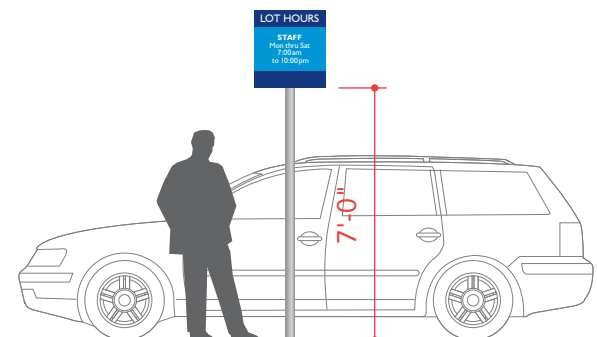

Back View

SIGN TYPE: PIN4

Information - Surveillance Notice

This sign type is to be used for identifying surveillance cameras around the campus. This sign is to be placed on poles in the general vicinity of the surveillance camera. Sign to be mounted no lower than 7'-0" to the bottom of the sign.

Front Colors: P1, P2

Sign Thickness: 1/4" aluminum panel

Exposed Edges: Paint colors to wrap edges

Sign Back: P2

Font: Humanst521 BT Bold

Letter Height: 1"

Graphics Material: V1

Post Information: See Page 14

Note: Structural requirements to be determined by a licensed structural engineer.

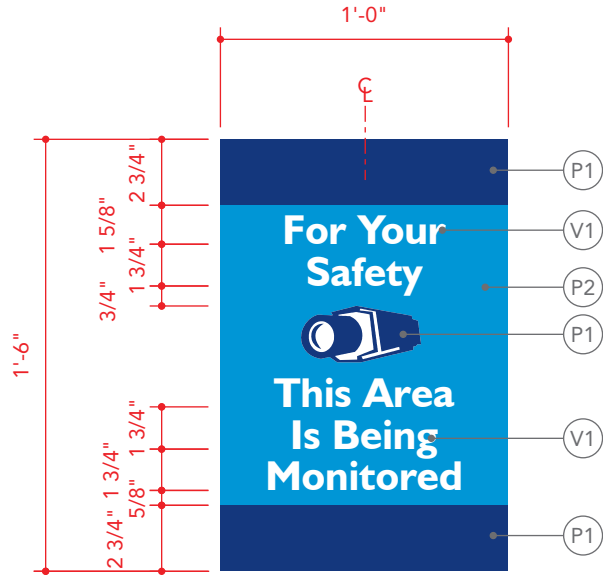

Scale: 1 1/2" = 1'-0"

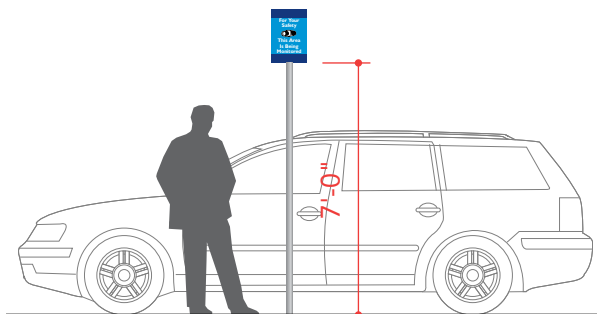

Back View

SIGN TYPE: PIN5

Parking Information - Motorcycle

This sign type is to be used for identifying restricted parking areas around the campus. This sign is to be placed on poles either at the head, or parallel to, the parking space or area. Sign to be mounted no lower than 7'-0" to the bottom of the sign.

Front Colors: P1, P2

Sign Thickness: 1/4" aluminum panel

Exposed Edges: Paint colors to wrap edges

Sign Back: P2

Font: Humanst521 BT Bold

Letter Height:

Text: 2 1/4"

Icon: 5"

Graphics Material: V2

Post Information: See Page 14

Note: Structural requirements to be determined by a licensed structural engineer.

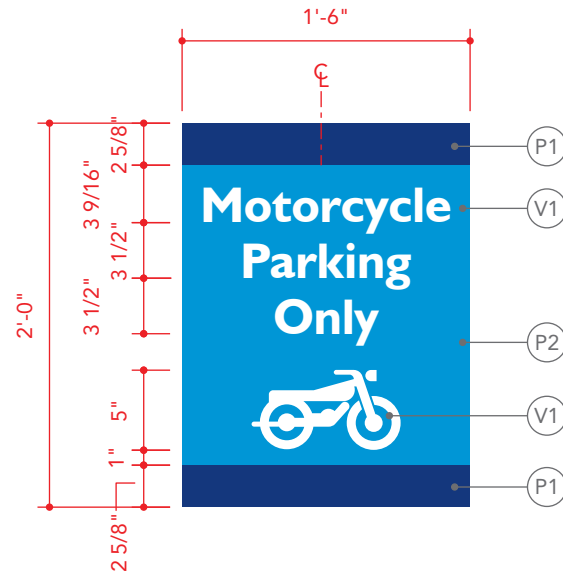

Scale: 1" = 1'-0"

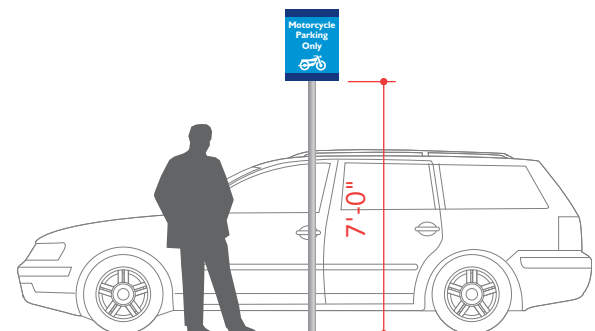

Back View

SIGN TYPE: PIN6

Parking Information - Electric Vehicle

This sign type is to be used for identifying electric vehicle charging parking areas around the campus. This sign is to be placed within 12" of the charging station facing the parking spot. Sign to be mounted no lower than 7'-0" to the bottom of the sign.

Front Colors: P1, P2

Sign Thickness: 1/4" aluminum panel

Exposed Edges: Paint colors to wrap edges

Sign Back: P2

Font: Humanst521 BT Bold

Letter Height:

Text: 1 3/4"

EV Icon: 7 3/4"

Graphics Material: V2

Post Information: See Page 142

Note: Structural requirements to be determined by a licensed structural engineer.

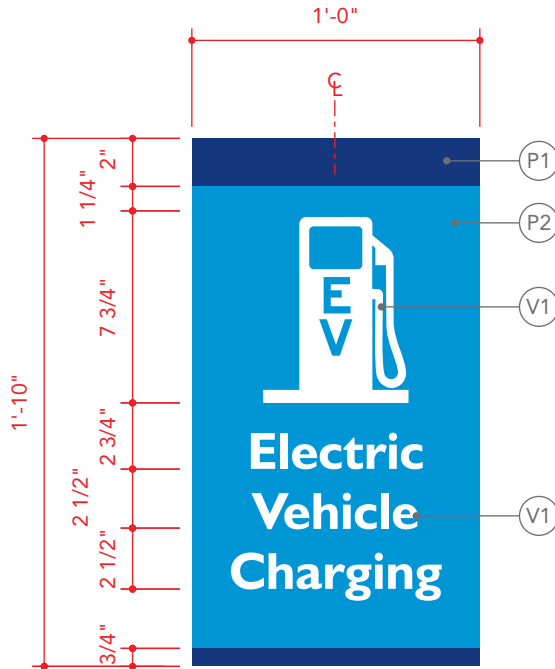

Scale: 1 1/2" = 1'-0"

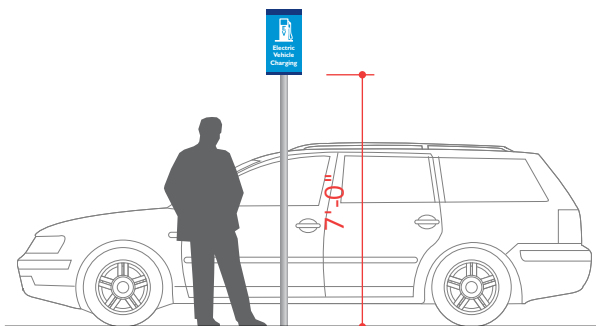

Back View

SIGN TYPE: PIN7

**Parking Information - Electric Vehicle
Charging Time Limits**

This sign type is to be used for identifying time limited electric vehicle charging parking areas or spaces around the campus. This sign is to be placed at the head of the parking space of the charging station facing the parking space. Sign to be mounted no lower than 7'-0" to the bottom of the sign.

Colors: Sign to be digitally printed in PMS 485 and PMS 356 on reflective vinyl.

Exposed Edges: Paint colors to wrap edges

Sign Thickness: 1/8" aluminum panel

Sides: 1

Sign Back: P2

Font: Match fonts & layout from previous job.

Graphics Material: V1

Post Information: Mount signs to 2 1/2" galvanized steel pole or wall. See detail on Page 13.

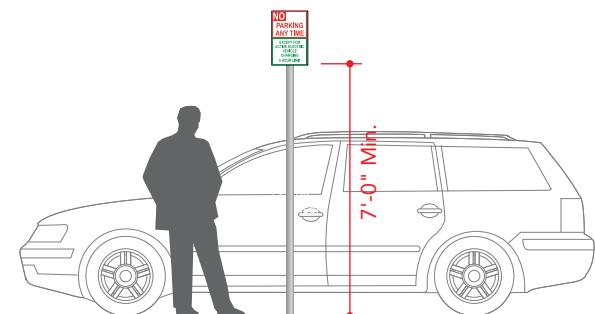
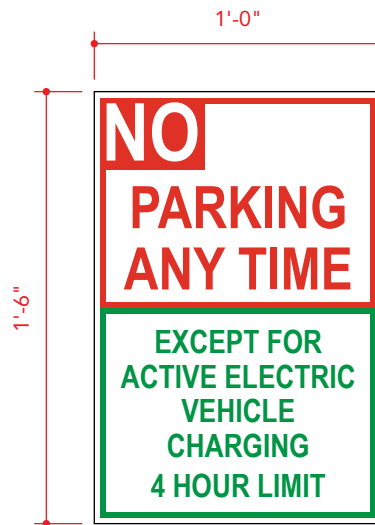

SIGN TYPE: AFI.01

Athletic Field Information - Danger Stay Back

This sign type is to be used for identifying dangerous situations at athletic fields. This sign is to be placed on fences or nets near the athletic field. Top of sign to be mounted no lower than 5'-0".

Colors: P1, P2

Exposed Edges: Paint colors to wrap edges

Sign Thickness: 1/8" aluminum panel

Sides: 1

Sign Back: Paint P2

Font:

Line 1: Humanst521 BT Bold

Lines 2 & 3: Humanst521 BT

Letter Height

Line 1: 2"

Lines 2 & 3: 1 3/4"

Graphics Material: V1

Mount: Signs to be mounted directly to fence or net.

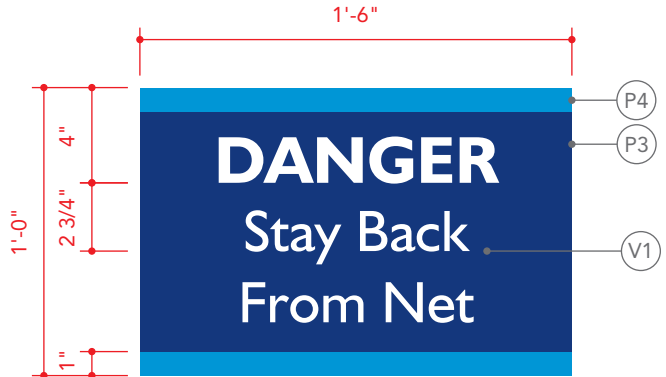

Scale: 1 1/2" = 1'-0"

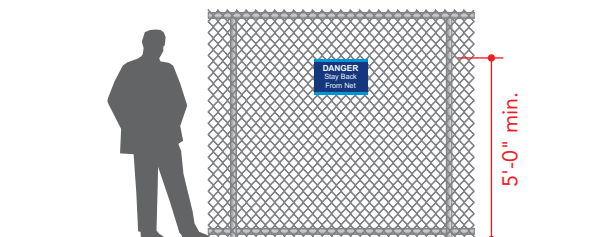

SIGN TYPE: AFI.02 & AFI.03

Athletic Field Information - Own Risk and Beware

This sign type is to be used for identifying dangerous situations at athletic fields. This sign is to be placed on fences or nets near the athletic field. Top of sign to be mounted no lower than 5'-0".

AFI.02 - Own Risk

Colors: P1, P2

Exposed Edges: Paint colors to wrap edges

Sign Thickness: 1/8" aluminum panel

Sides: 1

Sign Back: Paint P2

Font: Humanst521 BT, Humanst521 BT Bold

Letter Height: 1 3/16"

Graphics Material: V1



AFI.03 - Beware

Colors: P1, P2

Exposed Edges: Paint colors to wrap edges

Sign Thickness: 1/8" aluminum panel

Sides: 1

Sign Back: Paint P2

Font:

Line 1: Humanst521 BT Bold

Lines 2-6: Humanst521 BT

Letter Height

Line 1: 3"

Lines 2-3: 2"

Lines 4-6: 1 3/16"

Graphics Material: V1

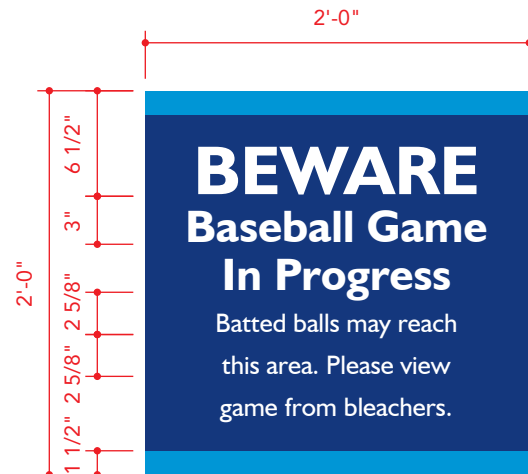

Mount: Signs to be mounted directly to fence or net.



Part 7

Orientation Signs

OR1 Orientation - Campus Directory

SIGN TYPE: OR1

Orientation - Campus Directory

This sign type is used to orient visitors and staff of their location within the campus. This sign should be located at all campus entrances and gathering spaces within the campus. Sign to be located on hardscape or within 6" of the edge of landscaped areas.

Colors: P1, P2, P3

Sides: 2 (both sides have the same art)

Exposed Edges: Paint colors to wrap edges

Sign Back: Sign can be single or double-sided.

Sign to be double-sided unless one side is obstructed from view by something like a tree, bushes, or a building. If sign is not double-sided, then header to be painted P1 and P2.

Font: Humanst521 BT Bold

Letter Height:

"DIRECTORY": 3"

Letter Color: V3

Map Area with Legend: 28" x 42"

Map: Full color process, digitally printed artwork on 3M ControlTac IJ - I80CV3 with comply adhesive and 3M 8519 Luster UV Laminate applied

Map Mounting: Applied to sign face

Orientation: Rotated to be "heads-up" or forward facing so that viewers are facing the map in the same direction that they are standing.

Post Information: See Page 12

Note: Structural requirements to be determined by a licensed structural engineer.

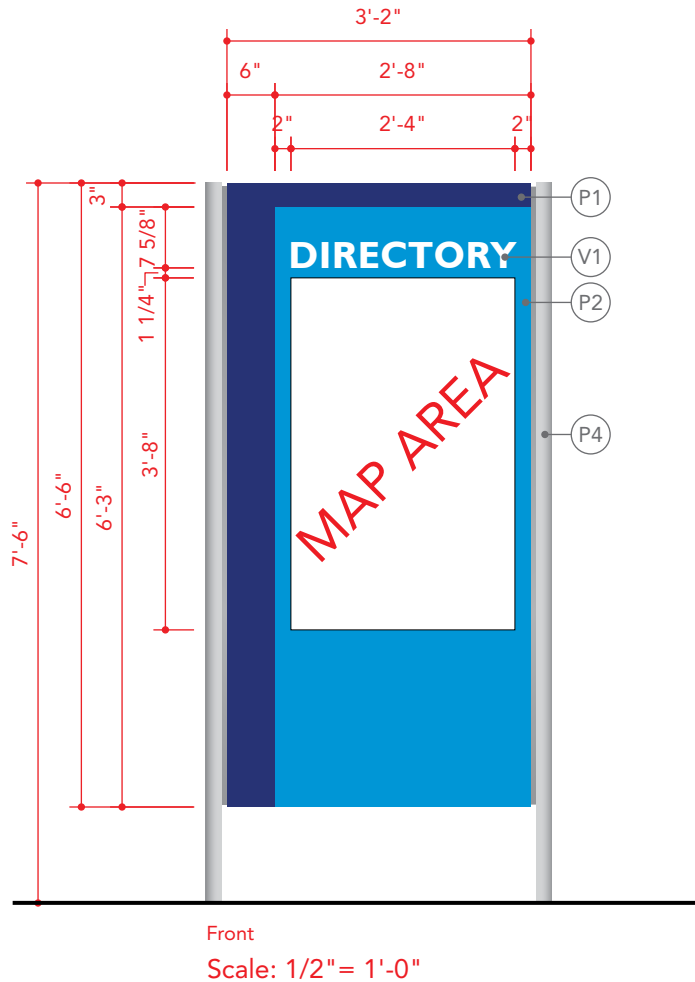

Part 8

Regulatory Signs

RG1 Regulatory Permit Parking

RG2 California Vehicle Code

RG3 Designated Parking

RG4 Smoking Prohibited

RG5 Smoking Prohibited Window Graphic

RG6 No Skateboarding

MUTCD Standard Regulatory Signs

AED Automatic External Defibrillator Window Decal

SIGN TYPE: RG1
Regulatory Permit Parking

This sign type is to be used for parking restriction information at parking lots around the campus. This sign is to be placed on poles at all entrance to parking lots, perpendicular to the street. Sign to be mounted no lower than 7'-0" to the bottom of the sign.

- Front Colors:** P1, P2
- Sign Thickness:** 1/4" aluminum panel
- Exposed Edges:** Paint colors to wrap edges
- Sign Back:** P2

- Font:** Humanst521 BT, Humanst521 BT Bold
- Letter Height**
- Lines 1-2: 1½" - Bold
- Lines 3-4: 1½" - Regular
- Lines 5-10: 1" - Regular
- Lines 11-13: 1½" - Bold
- Lines 14-16: 1" - Bold
- Graphics Material:** V1

Post Information: See Page 14

Note: Structural requirements to be determined by a licensed structural engineer.

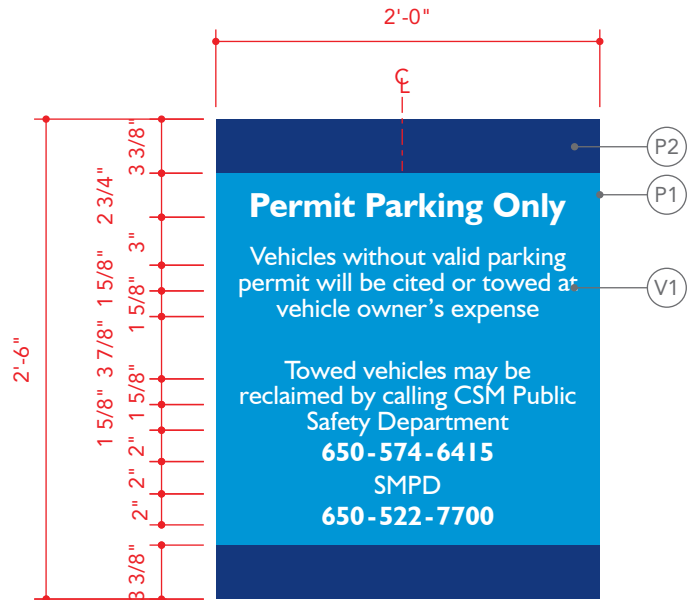

Scale: 1" = 1'-0"

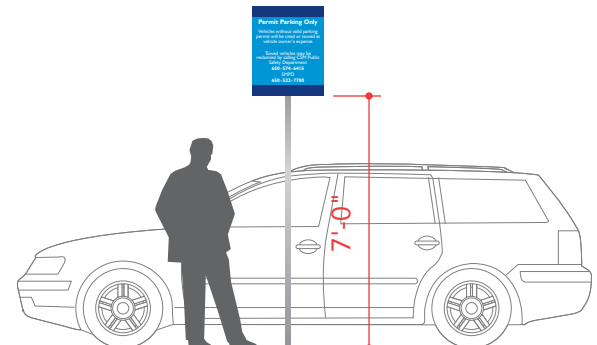

Back View

SIGN TYPE: RG2
California Vehicle Code

This sign type is to be used for vehicular code information on roadways around the campus. This sign is to be placed on poles at all entrances to the campus, perpendicular to the street. Sign to be mounted no lower than 7'-0" to the bottom of the sign.

- Front Colors:** P1, P2
- Sign Thickness:** 1/4" aluminum panel
- Exposed Edges:** Paint colors to wrap edges
- Sign Back:** P1

- Font:** Humanst521 BT
- Letter Height:** 1 3/4
- Graphics Material:** V1

Post Information: See detail on Page 14.

Note: Structural requirements to be determined by a licensed structural engineer.

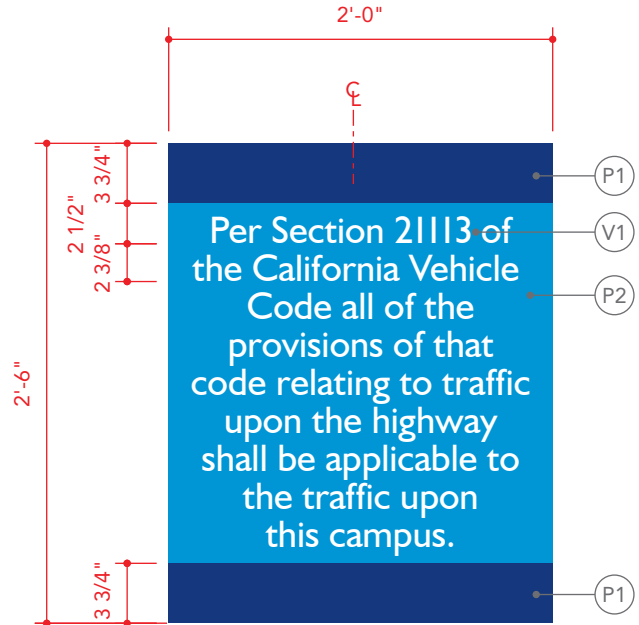

Scale: 1" = 1'-0"

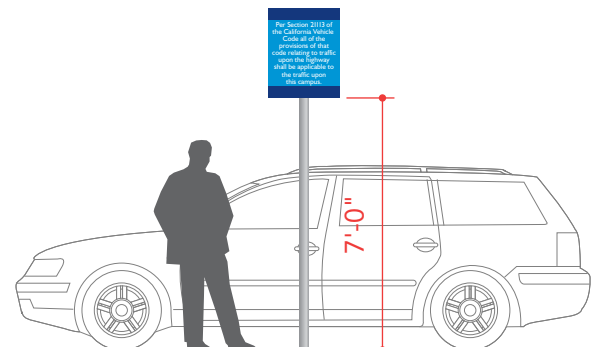

Back View

SIGN TYPE: RG3
Designated Parking

This sign type is to be used for parking restriction information at parking lots around the campus. This sign is to be placed on poles at all entrances to parking lots, perpendicular to the street. Sign to be mounted no lower than 7'-0" to the bottom of the sign.

Front Colors: P1, P2
Sign Thickness: 1/4" aluminum panel
Exposed Edges: Paint colors to wrap edges
Sign Back: P1

Font: Humanst521 BT, Humanst521 BT Bold
Letter Height
Lines 1-3: 1 1/2" - Bold
Bodycopy: 1 1/4" - Regular
Graphics Material: V1

Post Information: See detail on Page 14.

Note: Structural requirements to be determined by a licensed structural engineer.

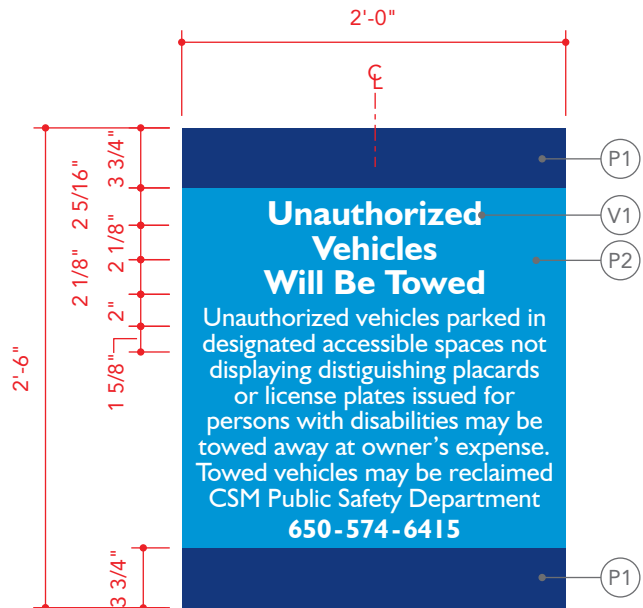

Scale: 1" = 1'-0"

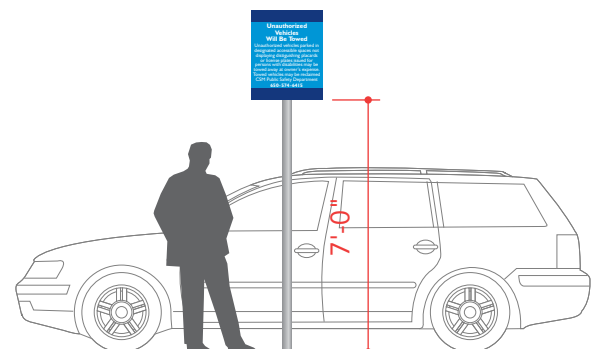

Back View

SIGN TYPE: RG4
Smoking Prohibited

This sign is to be used to identify where smoking is prohibited at buildings and areas. This sign is to be placed on walls where required on campus. This sign is to be placed facing pedestrians in the vicinity of the sign, mounted on a wall. Top of sign to be no higher than 5'-0".

Front Colors: P1, P2

Sign Thickness: 1/4" aluminum panel

Exposed Edges: Paint colors to wrap edges

Sign Back: P1

Font: Humanst521 BT Bold

Letter Height: 1/2"

Graphics Material: V1, V3



Scale: 3" = 1'-0"

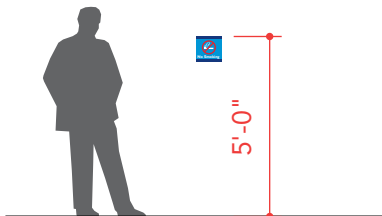

SIGN TYPE: RG5
Smoking Prohibited Window Graphic

This sign is to be used to identify where smoking is prohibited at buildings and areas. This sign is to be placed on the glass sidelight at building entrances. If no room on the glass sidelight, then sign should be placed on glass door following the same dimensions. All window graphics are to be placed on the first surface of the glass.

Colors: V1

Font: Humanst521 BT
Letter Height: 1 1/2"

Graphics Material: V1

Mounting Information: All window graphics are to be placed on the first surface of the glass.

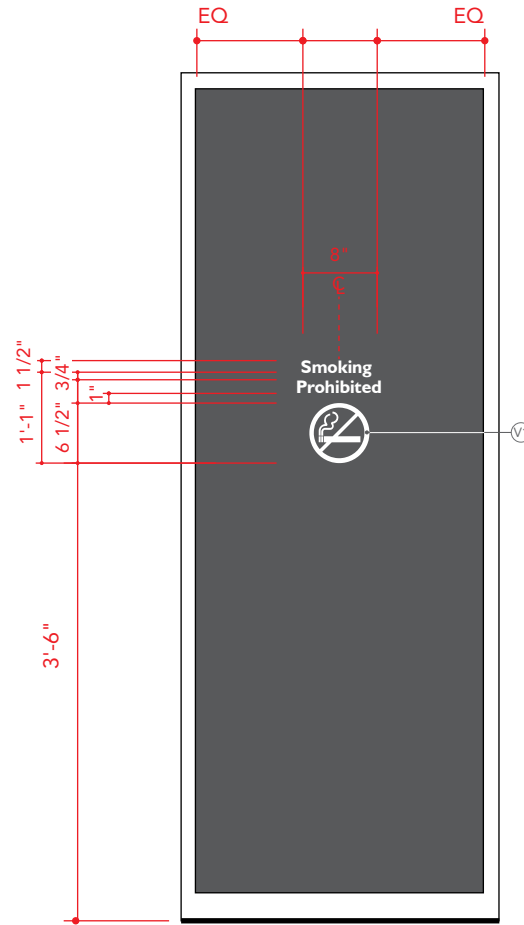

Scale: " 1/2" = 1'-0"

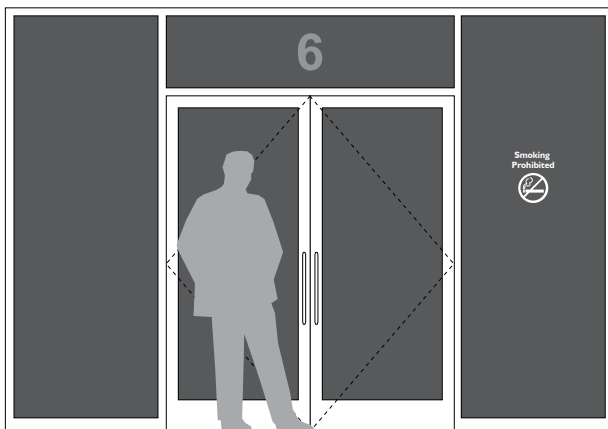

Scale: " 1/4" = 1'-0"

SIGN TYPE: RG6
Regulatory - No Skateboarding

This sign is to be used to identify where skateboarding is prohibited at buildings and areas. This sign is to be placed on wall where required on campus. This sign is to be placed facing pedestrians in the vicinity of the sign. Top of sign to be no higher than 4'-0". If mounted on a wall, top of sign to be no higher than 5'-0".

- Front Colors:** P1, P2
- Sign Thickness:** 1/4" aluminum panel
- Exposed Edges:** Paint colors to wrap edges
- Sign Back:** P2

- Font:** Humanst521 BT Bold
- Letter Height:** 1"
- Graphics Material:** V1, V3

Post Information: See detail on Page 14

Note: Structural requirements to be determined by a licensed structural engineer.

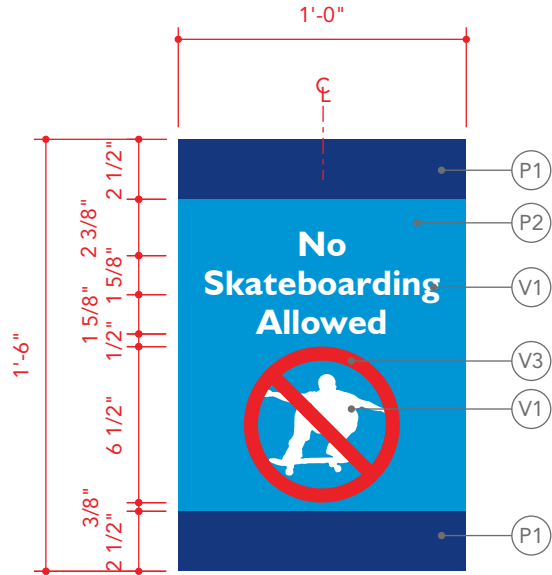

Scale: 1 1/2" = 1'-0"

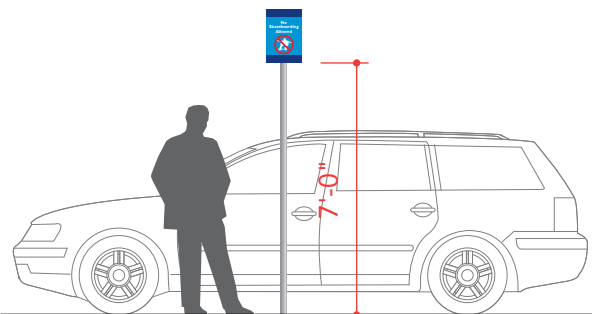

Back View

**MUTCD
Standard Regulatory Signs**

**Regulatory signs can be obtained from
Hawkins Traffic Supply via the contact
information listed below.**

Hawkins Traffic Safety Supply

1255 Eastshore Highway
Berkeley, CA 94710
800-772-3995
<http://www.hawkinstraffic.com>



10 14 00 Exterior Signage - College of San Mateo

SIGN TYPE: AED
Information- Automatic External
Defibrillator

This sign type can be ordered from the following vendor:

Smart Signs
<https://www.smartsign.com>
(800) 952 1457

AED Location Window Decal and Label
Size: 8" x 5" (H x W)
Material: Inside Glass Decal (graphics facing out)
Part #: S-4910-WD-WH-8x5

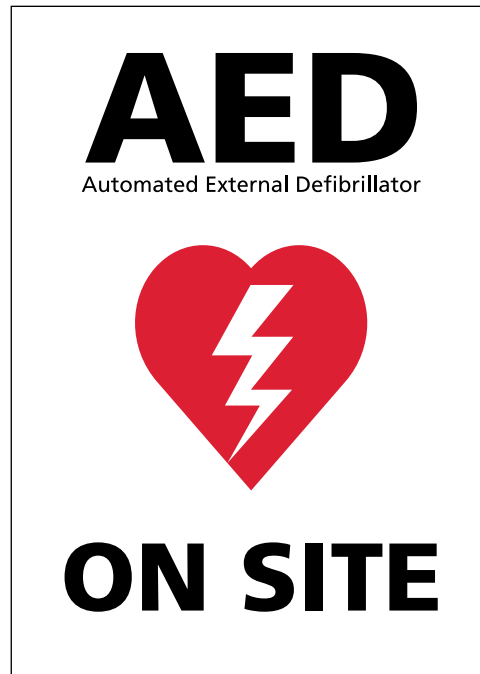

SECTION 10 14 00
EXTERIOR SIGNAGE
Design Standard

PART 1 GENERAL

1.1 RELATED SECTIONS & REFERENCE

- A. The General Conditions, Supplemental Conditions and General Requirements are hereby made a part of this Section as fully as if repeated herein.

- B. The Manufacturer shall be responsible for providing Signage and Graphic Products that comply with the documents listed below. If newer versions of these documents are in effect at the time of installation, then the Manufacturer is responsible for compliance with the newer versions.
 - 1. Current California Building Code (CBC).
 - 2. State of California, California Code of Regulations, Title 24, Volumes 1 and 2.
 - 3. California Department of General Services, Division of the State Architect, 2008 California Access Compliance Reference Manual, Checklist 17.
 - 4. Local City and County Municipal Codes.
 - 5. Americans with Disabilities Act (ADA) legislation, published in the Department of Justice Federal Register. Comply with all applicable provisions of the current ADA Standard for Accessible Design codes that apply to the State and Local jurisdiction of the project.

- C. San Mateo County Community College District Signage Manual
 - 1. College-specific design for each of the three campuses
 - a. Sign Types
 - b. Graphic Layouts
 - c. Colors
 - d. Typefaces
 - e. Hardware and sign component details

1.2 SCOPE OF WORK

- A. Bidders shall, as a part of their bid, call specific attention to any construction details, materials, methods of fabrication or other similar items which they consider to be impractical or not in keeping with good industry practice. Requests for change orders for substitutions to address such items after award of contract shall not be accepted.

- B. Scope of Work by Sign Type: To be specified on a project-by-project basis.

- C. Allowance for Submittals: Allow for thorough and complete preparation of all submittal items described in Section 1.4, for delivery and/or shipping of same, and for re-submittal(s) as required until approval has been obtained for all items.

1.3 STRUCTURAL DESIGN AND ENGINEERING

- A. Details in the Drawings indicate a general design approach for sign structures but do not necessarily include the specific fabrication details required for the complete structural integrity of the signs, nor do they necessarily consider preferred shop practices of individual contractors. Specific fabrication details shall be provided by the Sign Fabricator, who shall ensure that all signs withstand any and all static, dynamic and/or erection loads that act upon them, including all such loads associated with handling, erecting, and servicing.

- B. Sign Fabricator shall furnish a complete structural design for each sign type requested by the Owner, incorporating all reasonable safety factors necessary to protect the Owner and Design/Build Team against public liability.
 - 1. All such structural designs shall meet applicable local, state, and national codes, as well as testing laboratory listings, where required.
- C. Sign Fabricator shall be responsible for determining whether engineering is necessary on any individual sign and will be responsible for the engineering and internal construction. Fabricator shall submit shop drawings and details for review by the Owner's Representative. Shop drawings for engineered Sign Types shall be designed and stamped by a licensed Engineer currently registered in the State of California. Said stamped shop drawings shall specify all structural components and methods required to withstand the design wind load and design seismic load at the location of the sign(s).
 - 1. All structural design shall meet applicable local, state, and national codes, as well as testing laboratory listings, where required.
 - 2. Seismic Forces: Engineered shop drawings shall specify all necessary measures to withstand seismic forces at the project location.
 - 3. Wind Load: Engineered shop drawings shall reflect the soil type and compaction and the design wind load at the project location. Assume maximum wind of 80 MPH and wind pressure of 12.5 psf unless otherwise indicated. Comply with the requirements of Chapter 16 or 16A, Section 1609, of the CBC as apply.

1.4 SUBMITTALS

- A. Submit under provisions of Section 01 30 00 - Administrative Requirements.
- B. Pre-submittal Conference: Coordinate with the Owner's Representative prior to preparation of submittals to confirm submittal requirements and schedule. All items listed are required unless instructed otherwise by the owner, or the owner's representative.
- C. Product Data: Submit manufacturers' cut sheets, brochures, diagrams, schedules, charts, illustrations, Material Safety Data Sheets, test results and/or other standard descriptive data.
 - 1. Mark up each copy to identify pertinent materials, products or models.
 - 2. Show dimensions and clearances required, performance characteristics and capacities, and wiring diagrams and/or controls as apply.
 - 3. Submit materials descriptions and finishes for each type of sign.
- D. Shop Drawings:
 - 1. All shop drawings shall be neat, well organized and clearly legible. Elevations and plan views from the Construction Drawings may be reproduced for the sake of expedience where appropriate.
 - 2. All shop drawings shall be drawn to scale and not subsequently reduced to fit a drawing format.
 - 3. Sign Message Schedule: Submit spreadsheet in native Excel format indicating floor level, sign location number, sign type, quantity, sign message, and remarks.
 - 4. Submit plan view drawings for all sign types, including graphic layouts, complete dimensions, materials, locations of all exposed fasteners, colors, and finishes
 - 5. Submit comprehensive section drawings for sign types where applicable, including sections of all typical members. Show fabrication details, including details for securing members to one another. Show interior construction, reinforcements, fasteners, anchors, components, and finishes.

6. Submit installation drawings indicating overall dimensions, elevations, surface configuration and details of attachment to building structures, and/or to site work as well as relationship with adjacent materials/construction. Provide electrical source and connection information where applicable. Sign fabricator shall inspect site to verify installation conditions prior to submittal.
 7. Sign Location Plan: Submit floor plan drawings showing location and sign type for each sign that correlates to itemize Sign Message Schedule.
- E. Samples:
1. Color and Finish: Submit 3 each, minimum size 6 inch x 6 inch samples of all paint colors, screen colors, vinyl colors and material finishes. All paint and screen colors are to be applied to the appropriate substrate. Vinyl colors are to be trimmed directly off the roll and provided on the original liner.
 - a. Sign fabricator to submit verification of paint manufacturer used for submittal.
 - b. Prior to submittal, sign fabricator shall verify that all colors submitted as samples match accurately the samples and specifications.
 2. Typeface(s): Submit complete typeface font(s), including upper and lower case letters, numbers and punctuation, for all typeface(s) specified. Also, submit samples of letter and word spacing for each cap height specified.
- F. Prototypes:
1. Submit one full-size complete prototype each for the following Sign Types:
 - a. Exact sign types for prototypes to be determined by the Owner's Representative.
 - b. Substitutions, deletions, or additions to be determined by the Owner's Representative on a project-by-project basis.
 2. Submit one full-size partial prototype each for the following Sign Types:
 - a. Exact sign types for prototypes to be determined by the Owner's Representative.
 - b. Substitutions, deletions, or additions to be determined by the Owner's Representative on a project-by-project basis.
- G. Patterns: Submit one full size pattern each for Dimensional Letter Sign. All patterns shall be black vinyl graphics on a single carrier sheet and shall include the perimeter of the sign panel as applicable.
- H. Artwork and Approvals for Emergency Evacuation Plans (EEPs):
1. Owner's Representative shall provide digital artwork for one EEP to the Sign Fabricator. This artwork will serve as a template for the Sign Fabricator's use. Fabricator shall be responsible for obtaining approval on the initial design template by the Fire Marshall or authority having jurisdiction.
 2. Using said template and locations, Sign Fabricator shall generate digital artwork for all the other EEPs listed in the Sign Schedule. All artwork shall reflect accurately the graphic layout, graphic conventions and colors of the template. All EEPs shall be rotated to the appropriate orientation at each location to be right-reading when standing at the map location.
 3. Sign Fabricator shall then submit a complete set of to the Fire Marshall or authority having jurisdiction in accordance with their requirements and obtain their written approval.

1.5 MATERIALS

- A. Aluminum:
 - 1. Extruded Shapes: Provide alloy 6063; size as required, or as specified by Engineer.
 - 2. Flat Sheet: Provide alloy 3003; mill finish as specified, for all work that will receive a painted finish.

- B. Stainless Steel:
 - 1. Provide Alloy #304, Number 2B, in gauge(s) called out in the Construction Drawings.
 - 2. Provide mill finish on all surfaces to be painted and brushed finish on all surfaces to remain exposed.

- C. Cast Acrylic Sheet:
 - 1. Provide cast (not extruded or continuous cast) methyl plastic sheet, in sizes, thickness and finishes indicated, with a minimum flexural strength of 16,000 pounds per square inch when tested in accordance with ASTM D790, and a maximum allowable continuous service temperature of 176 degrees Fahrenheit.
 - 2. Cast acrylic sheet shall have a flame resistance such that application of a lighted match shall not produce melting, flashing, flaring or distortion. This material shall not ignite at a temperature less than 800 degrees Fahrenheit.
 - 3. Carefully follow manufacturer's recommended fabrication procedures regarding expansion/contraction, fastening and restraining of acrylic plastic.

- D. Polycarbonate Sheet:
 - 1. Provide impact-resistant extruded polycarbonate plastic sheet (Lexan or approved equal) in size, thickness and finish indicated, with a minimum tensile yield strength of 8,500 pounds per square inch when tested in accordance with ASTM D882-36T, and a maximum allowable continuous service temperature of 185 degrees Fahrenheit.
 - 2. Extruded polycarbonate sheet shall not ignite at a temperature less than 900 degrees Fahrenheit.

- E. Expanded PVC: Provide high density closed foam polyvinyl chloride sheet (Sintra or approved equal) in color(s) and thickness(es) specified.

- F. Tactile Signs (Exterior Grade):
 - 1. Provide Novacryl EX Series Photopolymer, exterior grade light-sensitive photopolymer layer of 0.032 inch (0.8 mm) thick exterior-grade photopolymer resin bonded to 0.016 inch (0.4 mm) thick aluminum alloy base composition. Contact Nova Polymers at www.novapolymers.com or call (888) 484-6682.
 - 2. Text and/or Graphics Finish: Provide multiplastic or other paint silkscreened for high adhesion. Coating shear lines to precisely reflect letterforms and/or graphic outline contours. Foil stamping is an acceptable substitution.

- G. Post & Panel Systems:
 - 1. Provide SignComp Aluminum Extrusion Sign Frame Systems.
 - a. Refer to College Exterior Signage Manual for Sign Types, Part Numbers and Specifications.

- H. Acrylic Polyurethane Paint:
 - 1. Provide acrylic polyurethane with ultraviolet inhibitors and lightfast, weather, abrasion and graffiti resistant additives as manufactured by Matthews Paint Company, (800) 323-6593. Prime and finish coats shall be mixed and applied in accordance with

- manufacturer's specifications. Paint finish shall be smooth, free of scratches, gouges, drops, bubbles, thickness variations, foreign matter or other imperfections.
- a. Provide a CCR Title 24 compliant non-glare finish for all interior applications.
 - b. Provide a satin finish for all exterior applications.
2. Colored Coatings for Cast Acrylic Sheet: Use paints for background color which are recommended by acrylic manufacturer for optimum adherence to acrylic surfaces and are non-fading for application intended.
 3. Design/Build Team shall provide verification of paint manufacturer used for all paint work.
- I. Vinyl Film: Provide opaque reflective or non-reflective vinyl film as indicated with pressure sensitive permanent adhesive backing; 3M Scotchcal High Performance vinyl or approved equal. All colors shall be integral and not surface applied except where custom color(s) are specified in the Drawings.
- J. Fasteners, Hardware and Devices: Stock proprietary fastening devices of approved standard manufacture such as cadmium plated screws, bolts and washers, and stainless steel hinges.
1. Conceal all fasteners except where noted or shown otherwise.
 2. Finish on all exposed devices to match overall sign finish, unless otherwise noted.
 3. Provide vandal-resistant fasteners at all exposed locations unless otherwise noted.
 4. Use fasteners fabricated from metals that are noncorrosive to either the sign material(s) or the mounting surface.
- K. Mounting Tape: Provide Very High Bond Tape #4905/.020"/clear and/or #4950/.045"/white closed cell acrylic foam carrier with VHB adhesive, very high solvent resistance and very high shear and peel adhesion, as manufactured by 3M Scotch or approved equal.
- L. Silicone Adhesive: GE Momentive RTV6708 Clear Silicone Adhesive, or approved equivalent.
- M. Quality Control:
1. Samples, mock-ups and prototypes shall not be permanently installed, but shall be retained by the Owner's Representative for record and quality control, unless otherwise noted by the Owner's Representative.
 2. If requested by Owner's Representative, submit manufacturer's installation instructions for each type of specialty sign. Include only pages which are pertinent, or manufacturer's standard drawings modified to delete non-applicable data.
- N. Substitutions
1. Requests for substitutions will be considered in accordance with provisions of Section 01 60 00 - Product Requirements.
- 1.6 QUALITY ASSURANCE
- A. Do not scale drawings for dimensions. Use only the written dimensions indicated on the Drawings, unless such be found in error. Sign Fabricator shall verify and be responsible for all dimensions and conditions shown by the Drawings, and shall visit the site to inspect and verify field conditions prior to fabrication and installation. The Owner's Representative shall be notified, in writing, of all discrepancies on Drawings, in field dimensions or conditions, and of changes required in construction details.

- B. Provide each type of sign as a complete unit produced by a single manufacturer, including all required mounting accessories, fittings and fastenings.
- C. All details shown in the Drawings shall be followed for exterior appearance. Minor changes in interior construction will be accepted in order to conform to Sign Fabricator's shop practices or engineering requirements when, in the sole judgment of the Owner's Representative, such changes do not detract materially from design concept or intent. Sign Fabricator shall circle all such changes on the shop drawings.
- D. Completed work shall be structurally sound, and free from scratches, distortions, chips, breaks, blisters, holes, splits or other disfigurements considered as imperfections for the specific material.

PART 2 PRODUCTS

2.1 MANUFACTURERS

- A. Acceptable sign fabricators must meet following criteria:
 - 1. A thorough description of three architectural signage projects, similar in character and scope to this project, which have been completed by the Bidder within the past three years. Note specifically any and all work performed by subcontractor(s) and identify subcontractor(s) for each subcontracted portion of the work. Include photographs, brochures, shop drawings or other relevant exhibits. Provide name, address and telephone number for client contact for each project.
 - 2. Approved sign fabricators:
 - a. JLA Architectural Signage, Jaime Arce (510) 938-9401
 - b. USA Signs, Jeff Aiello, (510) 633-7974
- B. Resumes for the following key personnel:
 - 1. Project Manager.
 - 2. Shop Fabrication Supervisor.
 - 3. Sign Installation Supervisor.
 - 4. All resumes shall include educational background, employment history, sign project experience in the same role to be performed for this project, client references, and percentage of time to be committed to this project during fabrication and installation.
- C. Three references for work completed within the past three years. Any or all of these references may be the client contacts included at Item 1 above.

2.2 FABRICATION

- A. Intent of Specifications: All finished work shall be of the highest quality in order to pass eye-level examination and scrutiny by Owner's Representative.
 - 1. Fabricate in accordance with manufacturer's instructions and approved shop drawings.
 - 2. All Work shall be free from burrs, dents, raw edges and sharp corners.
 - 3. Finish all welds on exposed surfaces as required so they are not visible in the finished Work.
 - 4. Finish all surfaces smooth unless otherwise indicated or specified.
 - 5. Surfaces which are intended to be flat, shall be free from bulges, oil canning, gaps or other physical deformities. Such surfaces shall be fabricated to remain flat under installed conditions.

6. Surfaces which are intended to be curved, shall be smoothly free-flowing to the required shape(s).
 7. Fabricate all cabinets, panels and components with smooth, mechanically finished edges. All edges shall be true, and all corners shall be square. Where edges are specified to be painted, fill and sand smooth as required prior to painting.
 8. Cut routed letterforms and/or graphics clean and true to match adjacent surface-applied letterforms and/or graphics.
 9. Fabricate all internally illuminated sign cabinets as required to provide a weather-tight housing for all lighting and electrical components.
 10. Exercise care to protect all polished and/or plated surfaces so that they remain unblemished in the finished work.
 11. Isolate dissimilar materials. Exercise particular care to isolate nonferrous metals from ferrous metals as required to prevent corrosion.
 12. All surfaces shall be flat to a tolerance of plus or minus 1/16' when measured at any point with a ten foot straight edge.
 13. All visible sign surfaces of the same type shall have the same finish. Color and/or finish shall be consistent across the entire surface of a sign.
 14. All reveals shall be of uniform width; all butt joints shall be tight and closed along the entire length; all access panels shall have a nominal, uniform gap all around.
 15. All expansion joints, when required, shall be positioned so as not to interfere with the look or finish of any sign message or the overall appearance of the sign face.
 16. All gaps between milled components, when assembled, shall not exceed a tolerance of 0.005".
- B. Provide colors and/or finish textures as specified or indicated in the Drawings or, where not specified or indicated, as selected by Owner's Representative.
1. Interior Colors/Finishes: Colors of sign graphics (text, arrows and/or symbols) shall have a minimum of 70% contrast with sign background behind graphics. Finish shall be non-glare on all sign backgrounds behind graphics on identifications and directional signs.
- C. Graphics: All text, arrows and symbols shall be provided in the sizes, colors, typefaces and spacing specified in the Drawings. All text shall be a true, clean, digitally or photomechanically accurate reproduction of the typeface(s) specified, with letterspacing and directional arrows as shown in the Drawings.
1. Lettering: Custom Typography: Per campus approved fonts.
 2. Arrows and Symbols: Use digital files provided by Owner's Representative in Adobe Illustrator CS6.
- D. Braille: Sign fabricator shall be responsible for the accurate translation of all applicable tactile copy to California standard Contracted Grade 2 Braille that shall comply with CBC Sections 11B-703.3 and 11B-703.4.
1. Braille dots shall have a domed or rounded shape and shall comply with Table 11B-703.3.1.
 2. The indication of an uppercase letter or letters shall only be used before the first word of sentences, proper nouns and names, individual letters of the alphabet, initials, and acronyms.
 3. Measurement ranges are as follows. Dot base diameter: 0.059 (1.5 mm) to 0.063 (1.6 mm). Distance between two dots in the same cell: 0.090 (2.3 mm) to 0.100 (2.5 mm). Distance between corresponding dots in adjacent cells: 0.241 (6.1 mm) to 0.300 (7.6 mm).

- mm). Dot height: 0.025 (0.6 mm) to 0.037 (0.9 mm). Distance between corresponding dots from one cell directly below: 0.395 (10 mm) to 0.400 (10.2 mm).
4. Braille shall be in a horizontal format.
 5. Braille shall be positioned below the corresponding text. If text is multi-lined, braille shall be placed below the entire text. Braille shall be separated 3/8 inch (9.5 mm) minimum and 1/2 inch (12.7 mm) maximum from any other tactile characters and 3/8 inch (9.5 mm) minimum from raised borders and decorative elements.
- E. Raised Letters and Graphics: Tactile Signs (Exterior Grade):
1. Manufactured to produce an etched surface with 1/32" relief copy and/or Braille dots after exposure to ultraviolet light, and with a minimum 95 Shore D durometer hardness rating. Photopolymer to be processed in accordance with manufacturer's instructions.
- F. Sign Schedule: Copy shown in the Drawings is for layout purposes only; all final copy, quantities and references for all signs are shown in the Sign Schedule. The Sign Fabricator shall clarify any perceived irregularities in the Sign Schedule with the Owner's Representative prior to fabrication.
- G. Digital Artwork: All digital artwork files prepared by the Owner's Representative for the Sign Fabricator's use shall be in a single layer. Any and all manipulations of the files required for subsequent use by the Sign Fabricator, such as spreads and traps for screened negatives, or conversion to outline or EPS, shall be the responsibility of same unless explicitly agreed otherwise by the Owner's Representative.

PART 3 EXECUTION

3.1 INSPECTION

- A. Owner's Representative reserves the right to inspect the Work in the Sign Fabricator's shop before it is shipped to the job site for installation.
- B. Sign Fabricator shall inspect all installation locations for conditions that will adversely affect the execution, permanence and/or quality of the Work, and notify Owner's Representative in writing of any and all unsatisfactory conditions. Sign Fabricator shall not proceed with installation until said unsatisfactory conditions have been corrected. Commencement of installation indicates acceptance of site conditions and guarantees delivery of an acceptable product.
- C. Signs and identification devices shall be field inspected after installation and approved by the enforcing agency prior to the issuance of a final certificate of occupancy per Chapter 1, Division II, Section 111, or final approval where no certificate of occupancy is issued. The inspection shall include, but not be limited to, verification that braille dots and cells are properly spaced and the size, proportion and type of raised characters are in compliance with these regulations.

3.2 SIGN LOCATIONS

- A. Tactile characters on signs shall be located 48 inches (1220 mm) minimum above the finish floor or ground surface, measured from the baseline of the lowest Braille cells and 60 inches (1525 mm) maximum above the finish floor or ground surface, measured from the baseline of the highest line of raised characters as per CBC 11B-703.4.

- B. Where a tactile sign is provided at a door, the sign shall be located alongside the door at the latch side. Where a tactile sign is provided at double doors with one active leaf, the sign shall be located on the inactive leaf. Where a tactile sign is provided at double doors with two active leaves, the sign shall be located to the right of the right hand door. Where there is no wall space at the latch side of a single door or at the right side of double doors, signs shall be located on the nearest adjacent wall.
- C. Signs containing tactile characters shall be located so that a clear floor space of 18 inches (455 mm) minimum by 18 inches (455 mm) minimum, centered on the tactile characters, is provided beyond the arc of any door swing between the closed position and 45 degree open position. Where permanent identification signage is provided for rooms and spaces they shall be located on the approach side of the door as one enters the room or space. Signs that identify exits shall be located on the approach side of the door as one exits the room or space.
- D. Symbols on restroom doors shall be located in compliance with CBC 11B-703.7.2.6: Center of sign to be 60 inches above finished floor. Sign to be centered left to right on door.
- E. Firefighters' Information signs in enclosed stairwells shall be located in compliance with Title 19: Bottom of sign to be 4'-0" above stair landing floor or as directed by Fire Department. Sign shall be placed beyond door swing for optimal visibility from stair legs above and below landing.
- F. Emergency Evacuation Map: Bottom of sign to be 4'-0" above finish floor or as directed by Fire Department.

3.3 INSTALLATION

- A. For ADA Signs: ADA sign are to mounted 60" to top of sign, centered on 18" from edge of door on the latch side, so that a person may approach without encountering protruding objects within the door swing. If no space is available on the latch side of the door, the sign can be placed on the opposite side of the door as stated above. Tactile copy baseline and Braille copy are to be placed no higher than 60" to the baseline or 48" to the bottom of the Braille copy. Signs to be mounted using VHB Tape and silicone adhesive.
- B. Pre-installation Walkthrough / Field-Staking: Attend a pre-installation walkthrough at the job site to confirm all typical installation conditions and determine installation locations for non-typical conditions. The exact locations for all exterior signs will be determined and field-staked at this time. Do not begin excavation for the footing for any exterior sign until the field-staked location has been approved by the Owner's representative.
- C. Provide reinforced concrete footings where required, with plan dimensions as shown and depth as specified by Engineer. Use Sonotube type form-work for post and panel signs at all landscape locations; core drill and set post(s) in epoxy grout at all hard scape locations.
- D. Where a concrete footing is level with finished grade to serve as a mow strip, slope the top of the footing away from the sign cabinet or post(s) minimally as required for drainage and to prevent puddling.
- E. Securely attach all signs to footings or site work in accordance with Engineer's specifications.

- F. Fence Mount: Securely attach all signs to signs or fences in accordance with Engineer's specifications.

3.4 SITE CLEANUP

- A. Final cleanup:
 1. Clean and/or repair all evidence of installation work or damage to site work or other adjacent surfaces prior to completion of work.
 2. Clean up work area after all installation has been completed. Restore all disturbed ground cover.
 3. Remove all protective materials and dispose of properly off site.

3.5 CLEANING AND PROTECTION

- A. At completion of installation, clean all sign surfaces in accordance with manufacturer's instructions.
- B. Protect all signs from damage until acceptance by Owner's Representative; repair or replace damaged units as required.
- C. Clean and/or repair all evidence of installation work or damage to adjacent surfaces prior to completion of work.
- D. Remove all protective materials and dispose of properly off site.

3.6 LIMITED ONE-YEAR WARRANTY

- A. The fabricator shall warranty any defect due to faulty material or workmanship for one year from date of invoice. The fabricator shall repair or replace the product without charge, providing it has been installed according to design and installation specifications. The fabricator shall be responsible for removal, disposal, reinstallation, and all associated costs of said product.

3.7 CONTRACT CLOSE-OUT ITEMS

- A. Provide Owner with one quart of paint for each paint color specified.
- B. Provide Owner with written instructions for proper cleaning of the signs, including cleaning solution, tools, and/or materials. Note any solvents that should not be used.

END OF SECTION