

GUSSET AND CROSS BRACING
SCALE: HALF

1
S-8

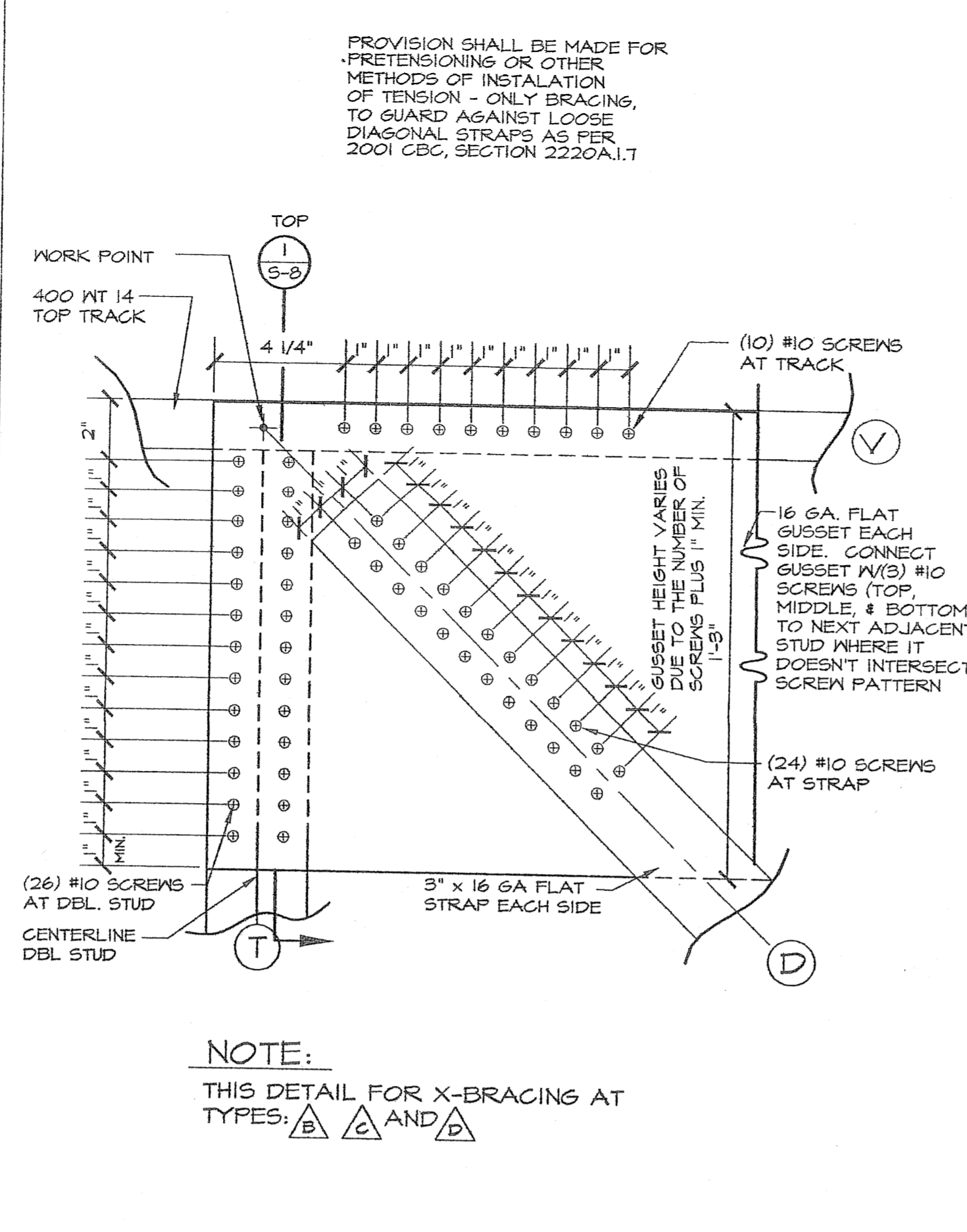

TOP GUSSET AT STRAIGHT WALL X-BRACING
SCALE: 3" = 1'-0"

2
S-8

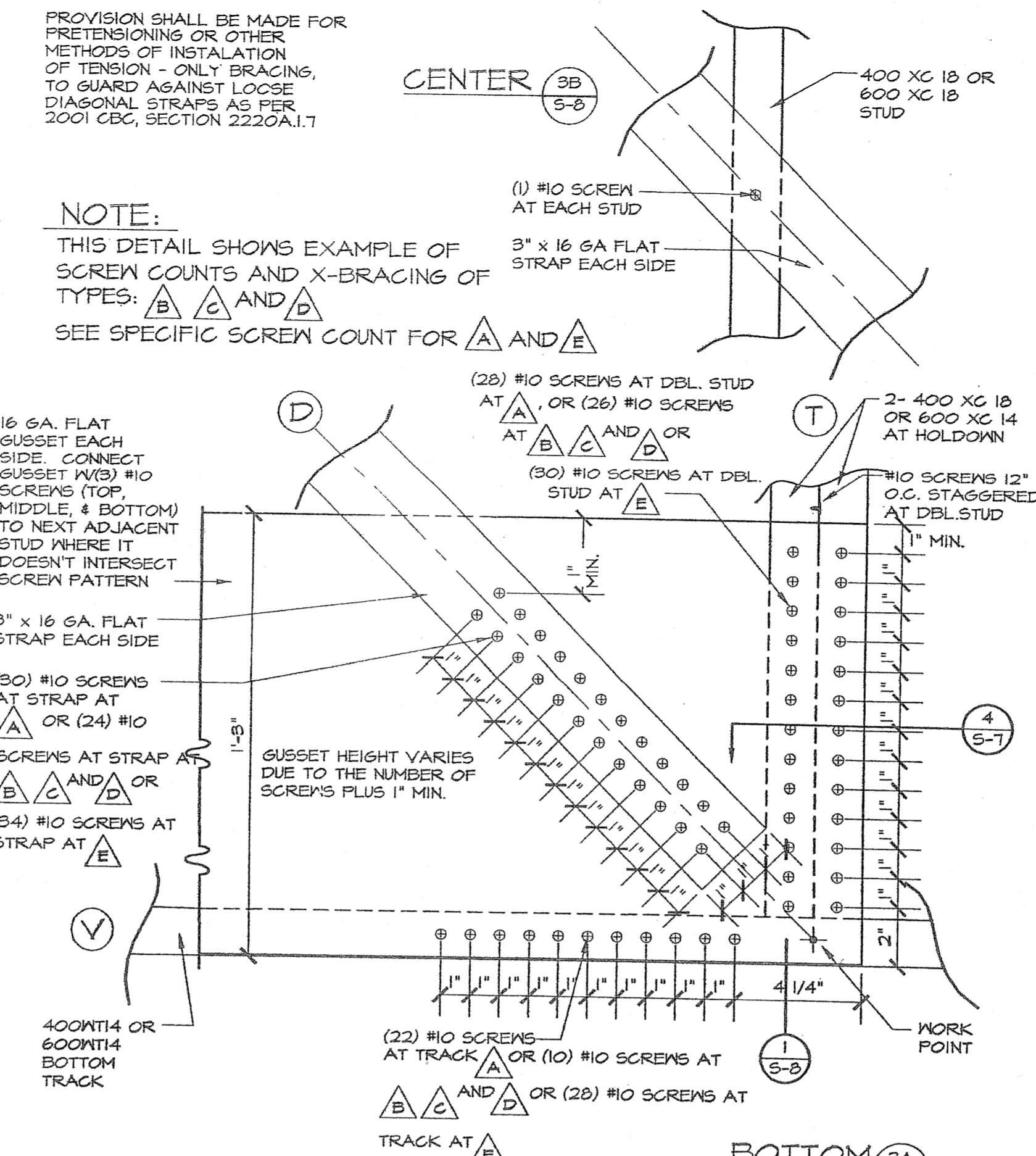

TYPICAL CENTER & BOTTOM GUSSET AT X-BRACING
SCALE: 3" = 1'-0"

3
S-8

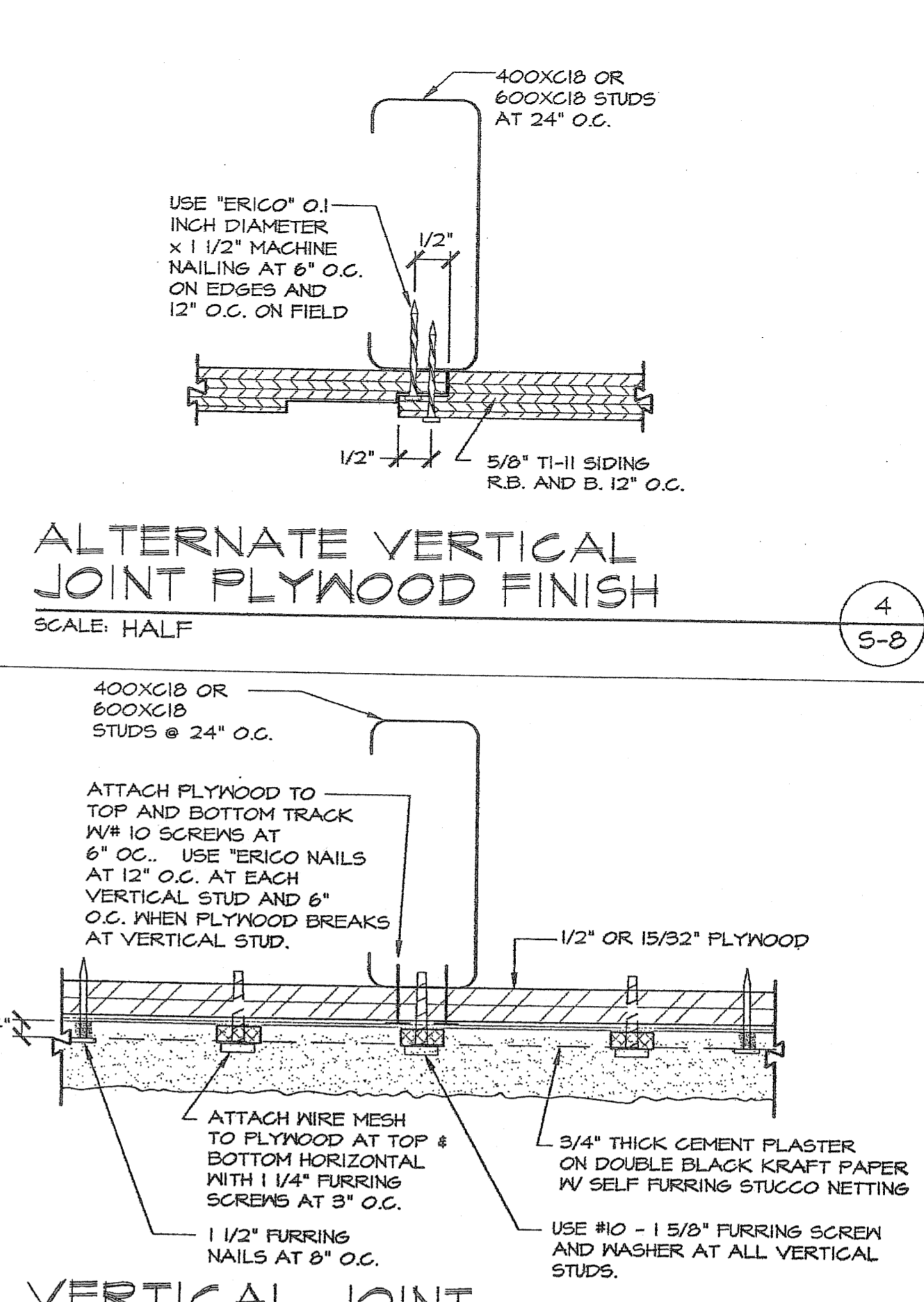

VERTICAL JOINT STUCCO FINISH
SCALE: HALF

5
S-8

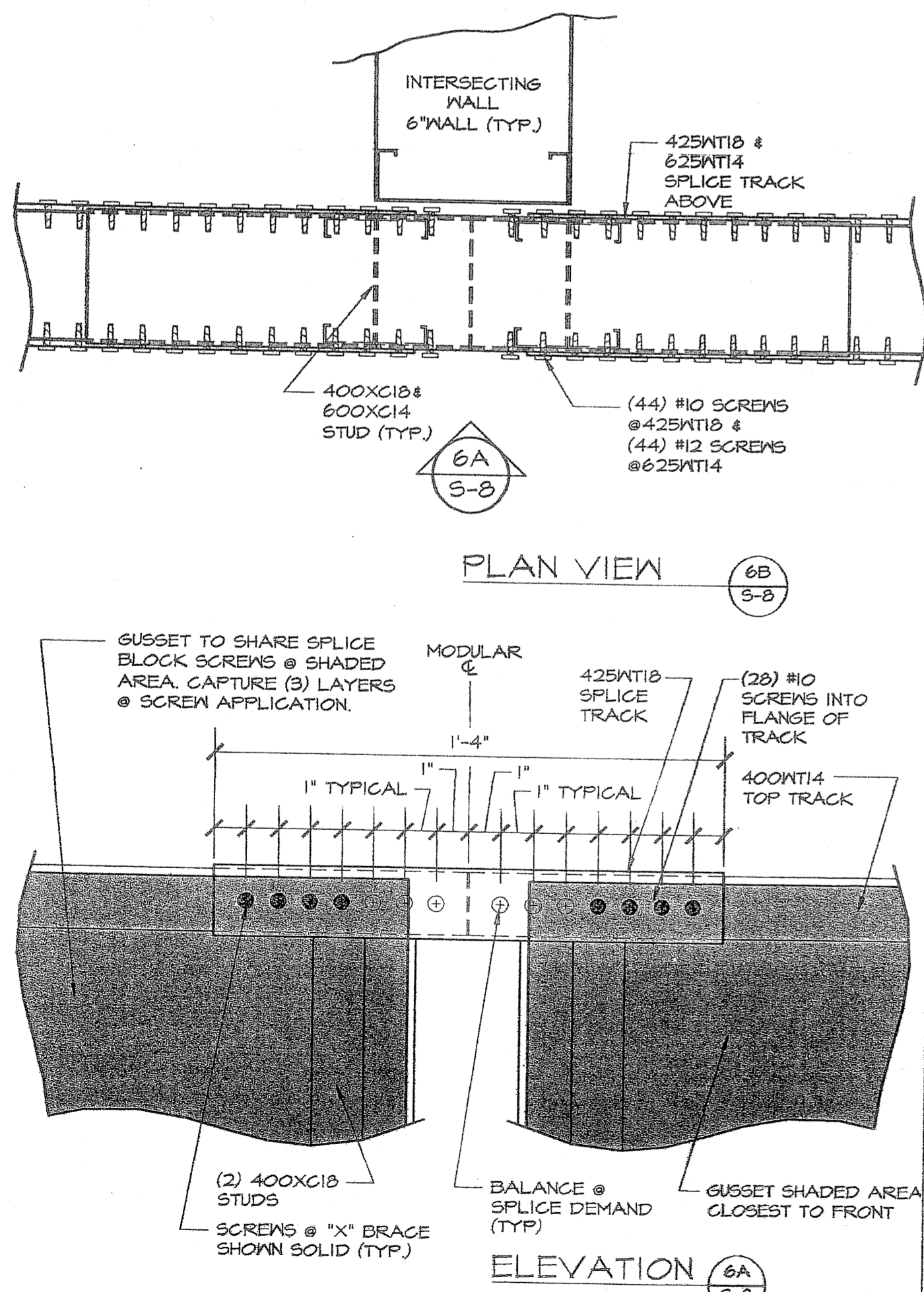

TOP TRACK MODULAR SPLICE
SCALE: 3" = 1'-0"

6
S-8

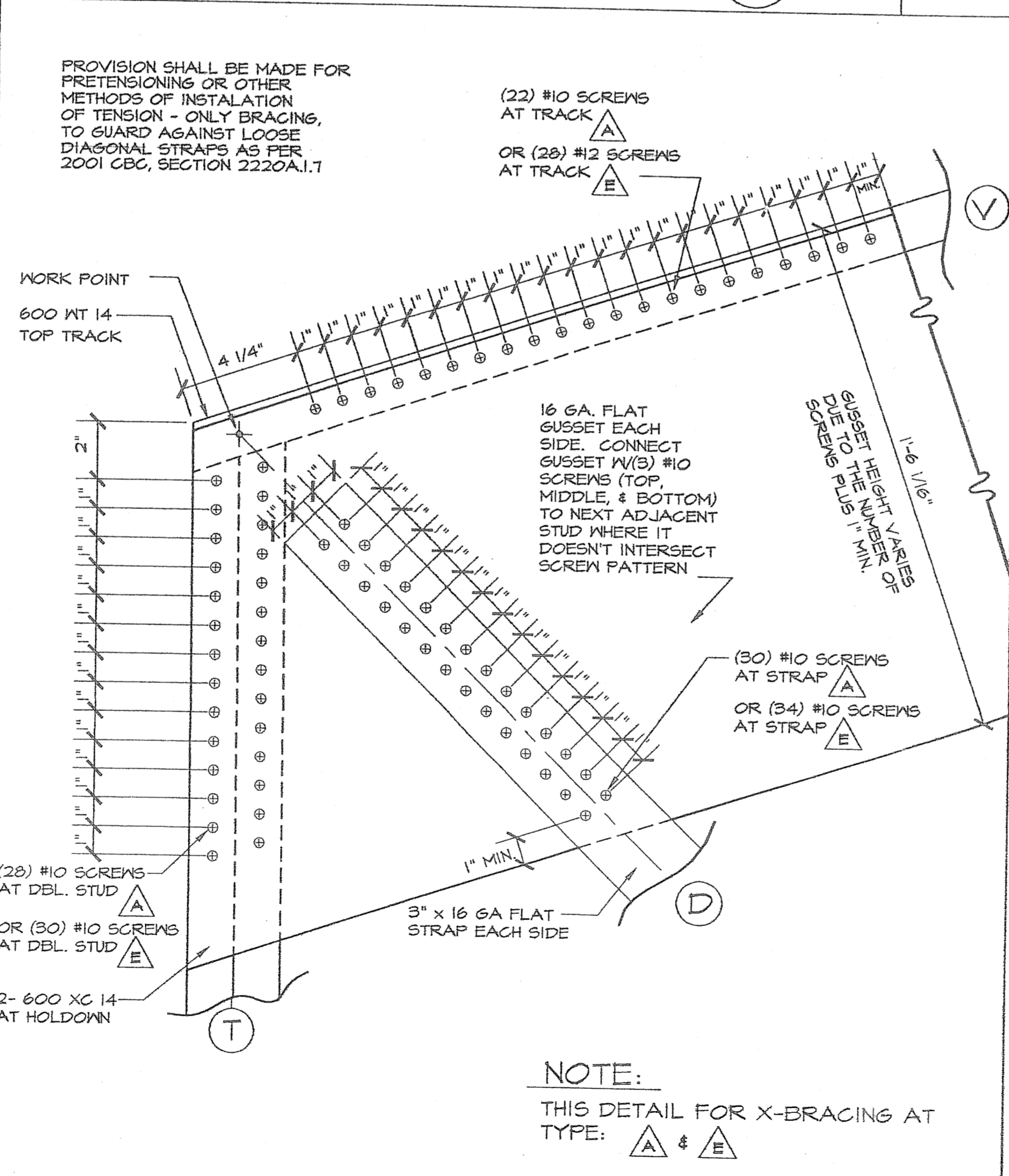

TOP GUSSET AT RAKED WALL X-BRACING
SCALE: 3" = 1'-0"

7
S-8

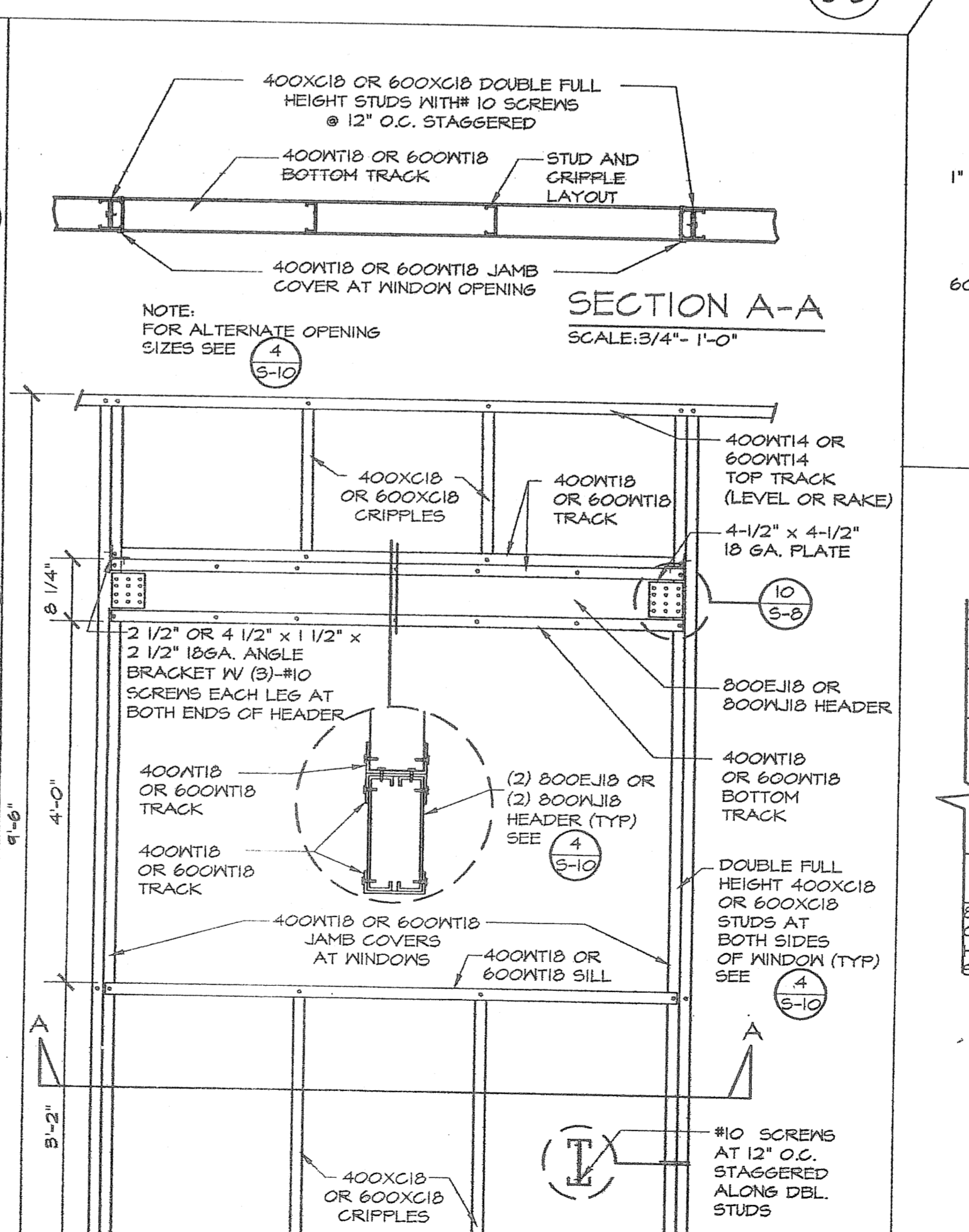

TYPICAL HEADER & SILL
SCALE: 3/4" = 1'-0"

8
S-8

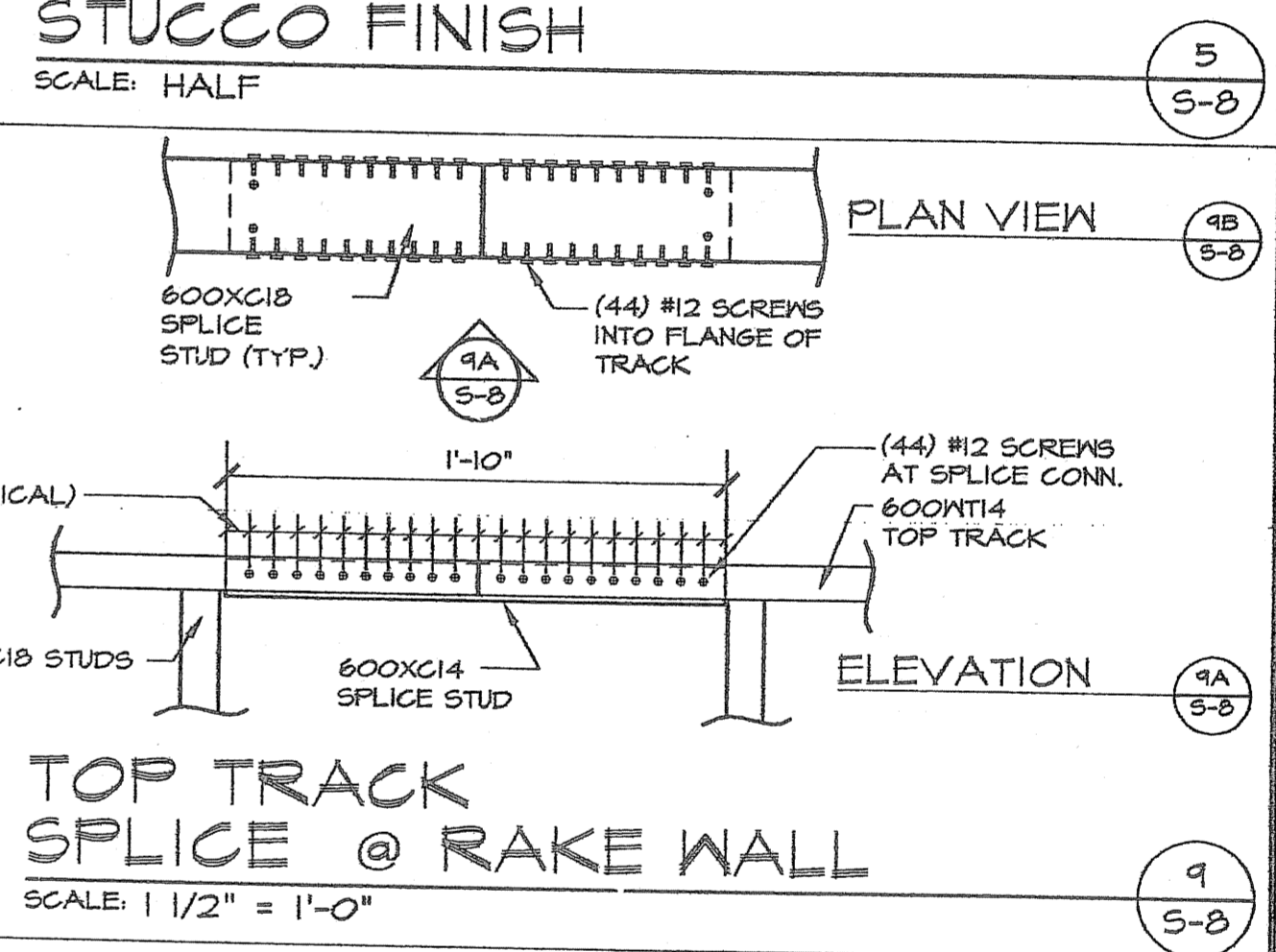

TOP TRACK SPLICE @ RAKE WALL
SCALE: 1 1/2" = 1'-0"

9
S-8

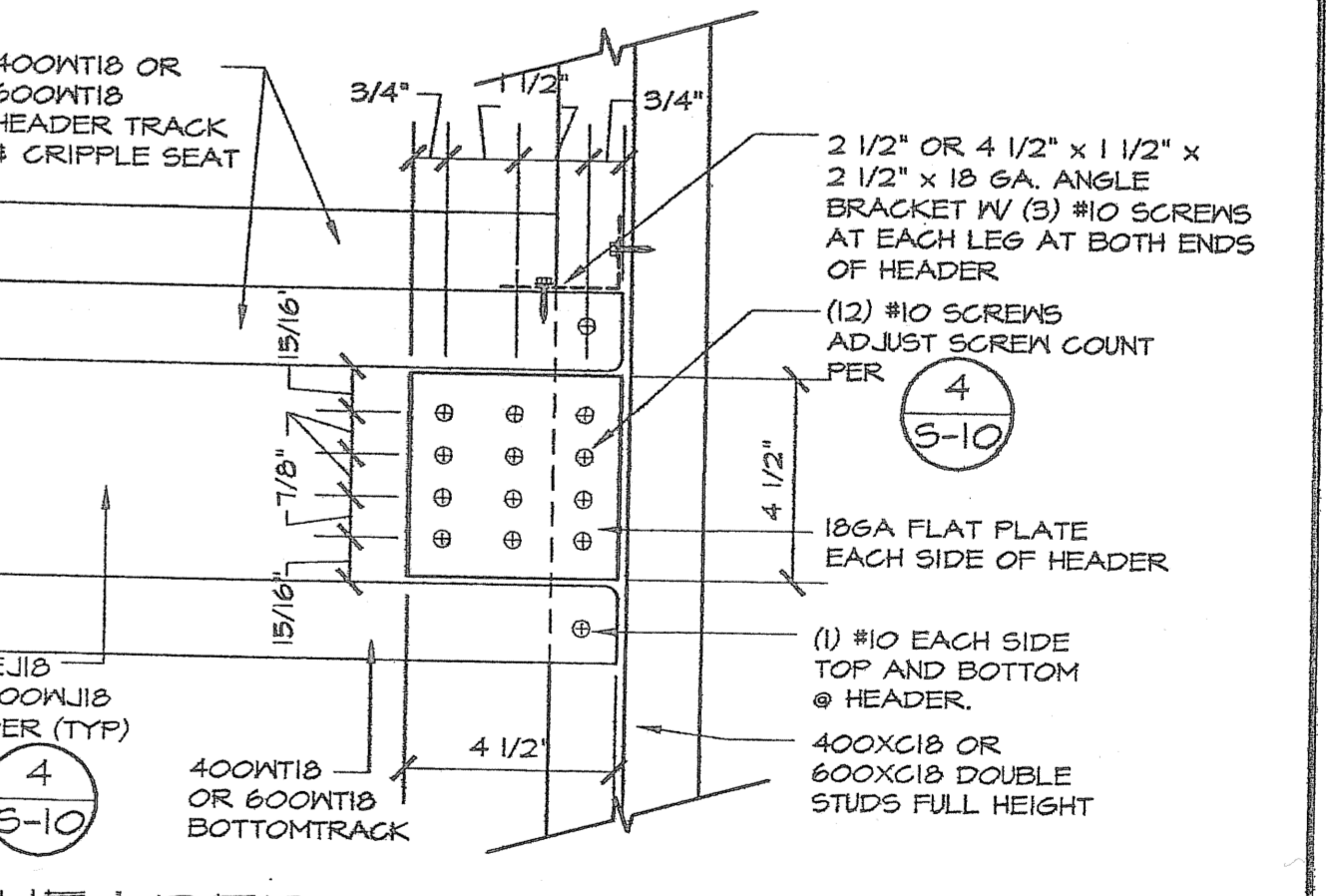

HEADER CONNECTION
SCALE: 3" = 1'-0"

10
S-8

ARCHITECT OF RECORD: [Signature]

SITE SPECIFIC APPLICATION NO. [Blank]

IDENTIFICATION STAMP
DIV. OF THE STATE ARCHITECT
OFFICE OF REGULATION SERVICES

PO 01-105106

AC. FLS. SS. [Initials]

DATE: JUL 17 2003

DRAWN: DESIGN TEAM

DATE: 11/15/02

CHECKED: DESIGN TEAM

SCALE: AS SHOWN

PROJECT: 1226

IDENTIFICATION STAMP
DIV. OF THE STATE ARCHITECT
OFFICE OF REGULATION SERVICES

01-108848

AC. FLS. SS. [Initials]

DATE: OCT 14 2007

REVISIONS	
1	
2	
3	
4	
5	
6	
7	
8	
9	
10	

COPYRIGHT © 2002 TO BE USED IN THE YEARS 2003 - 2005. SARAMARK, INCORPORATED

THESE PLAN DRAWINGS ARE PROPRIETARY DOCUMENTS OF SARAMARK, INCORPORATED & ARE NOT TO BE DISTRIBUTED, PUBLISHED OR REPRODUCED WITHOUT THE WRITTEN CONSENT OF SARAMARK INCORPORATED.

EC CONSULTING GROUP

1250 AVIATION AVE
SUITE 200-F
SAN JOSE, CA 95110
TEL: (408) 294-6918

4000AX SERIES "EXPO 2001"

CLASSROOMS WITH 40' SPAN SCISSOR TRUSS

SARAMARK INCORPORATED

SERIES 4000AX EXPO

P.O. BOX 24389
SAN JOSE, CALIFORNIA 95194
TEL: (408) 971-3851
FAX: (408) 971-3854

TYPICAL STRUCTURAL DETAILS

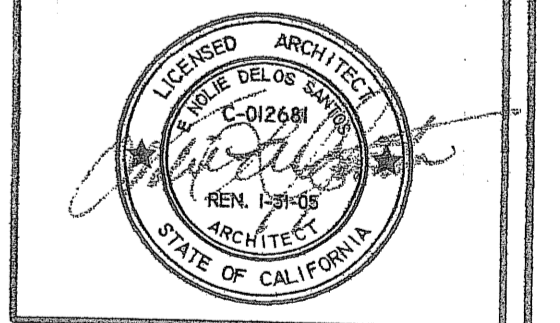

IDENTIFICATION STAMP
DIV. OF THE STATE ARCHITECT
OFFICE OF REGULATION SERVICES

PO 01-105106

AC. FLS. SS. [Initials]

DATE: JUL 17 2003

DRAWN: DESIGN TEAM

DATE: 11/15/02

CHECKED: DESIGN TEAM

SCALE: AS SHOWN

PROJECT: 1226

S-8