

1 RACING LANE LINE 1/2" = 1'-0"

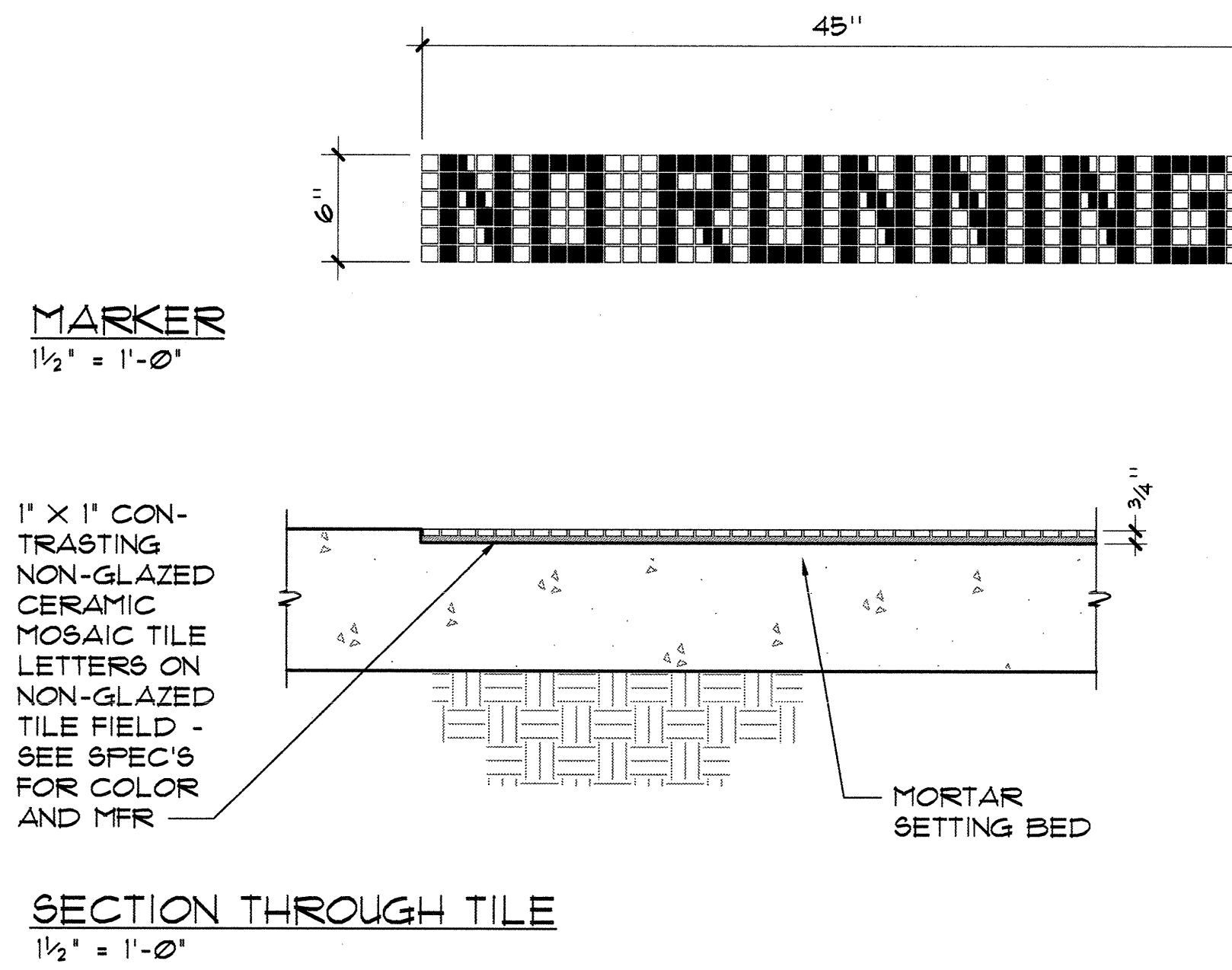

2 SECTION THROUGH TILE 1/2" = 1'-0"

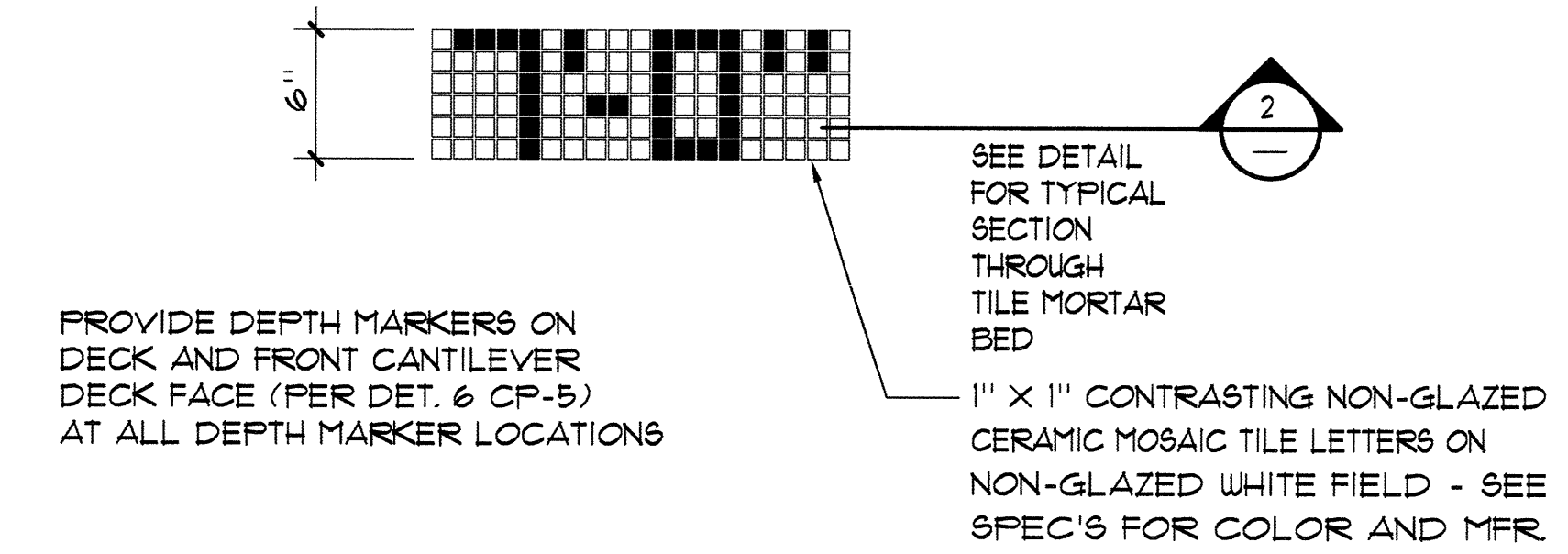

3 DEPTH MARKERS 1/2" = 1'-0"

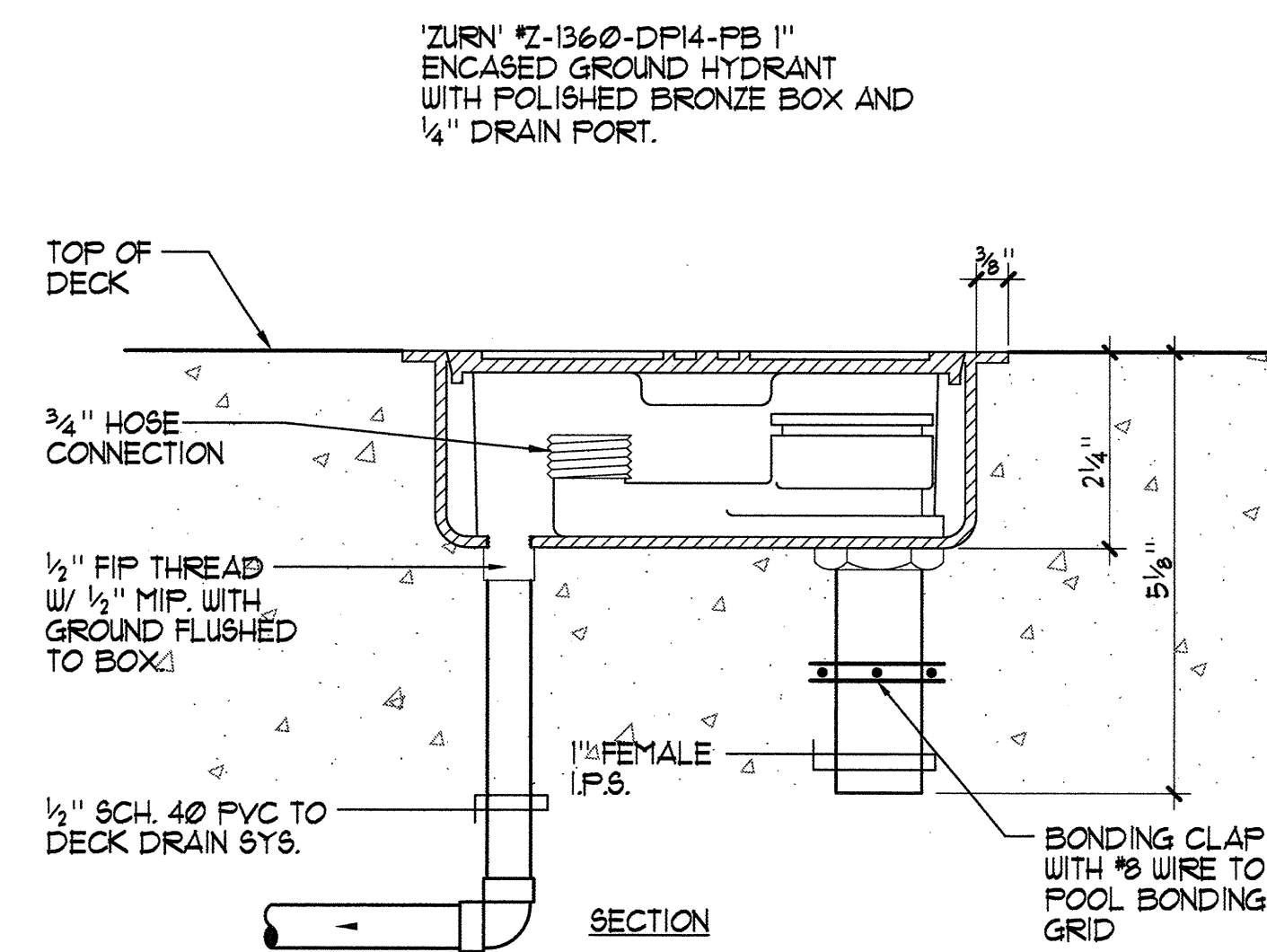

4 HOSE BIBB NO SCALE

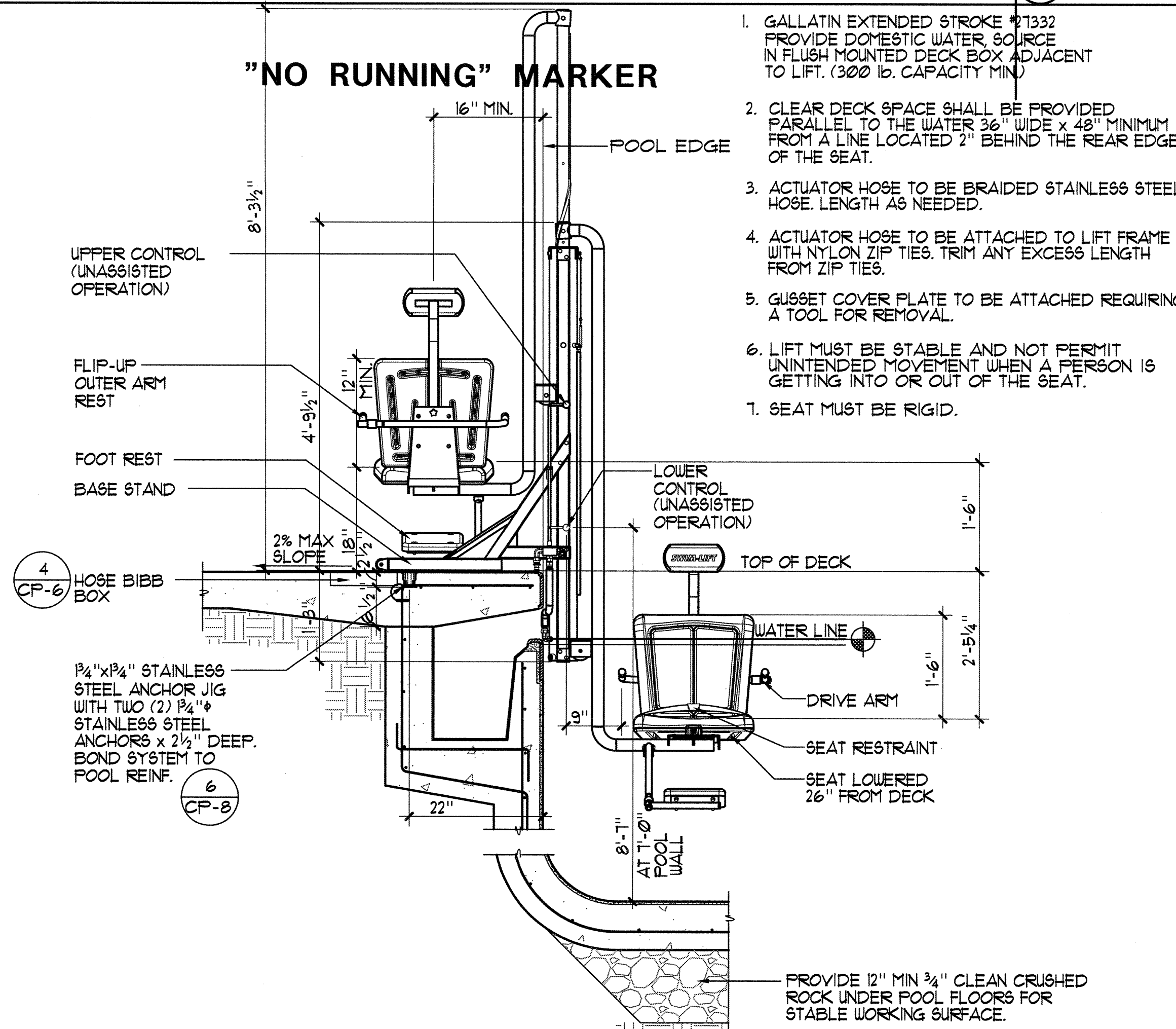

5 DISABLED LIFT 3/4" = 1'-0"

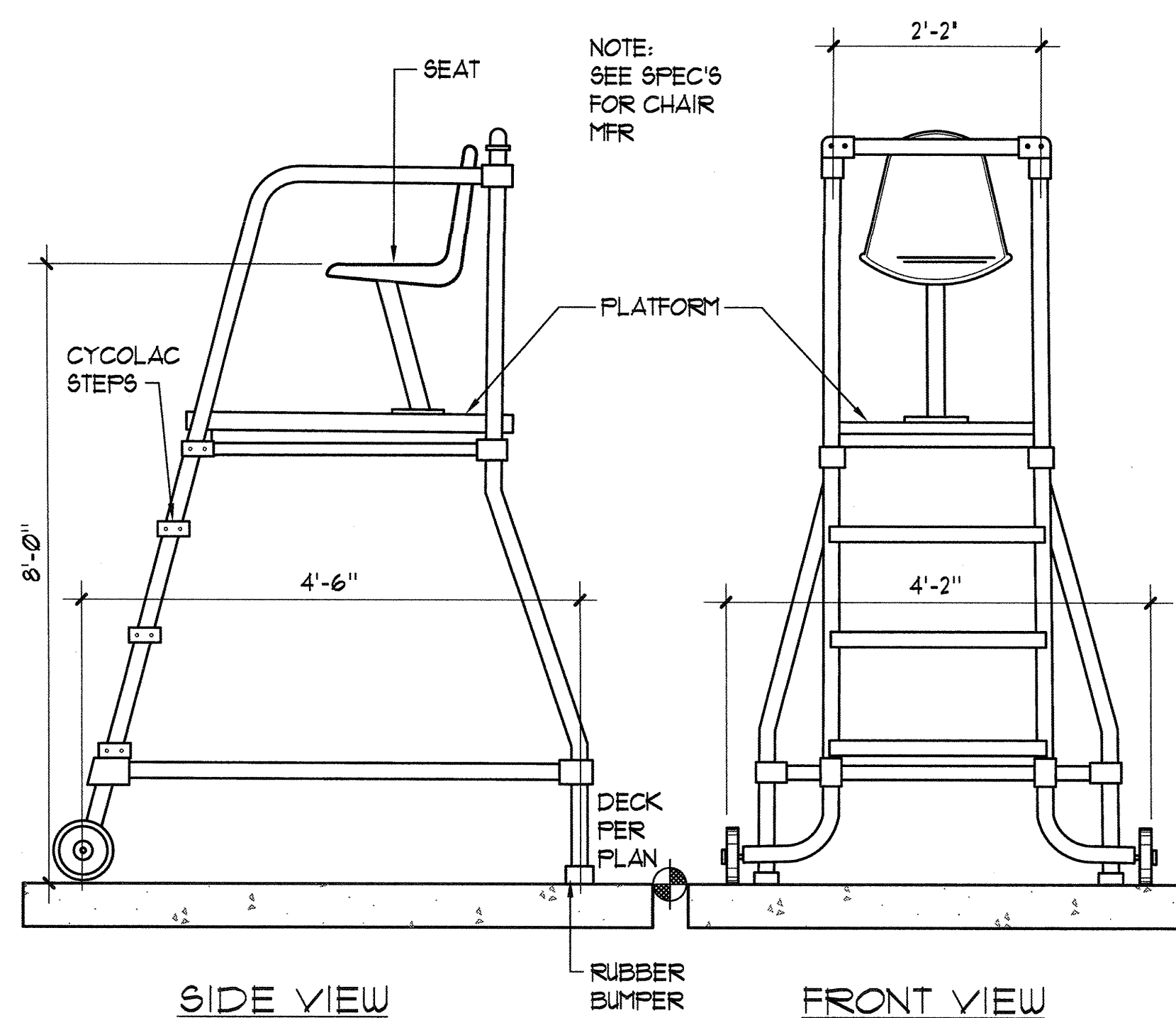

6 MOVEABLE LIFEGUARD CHAIR NO SCALE

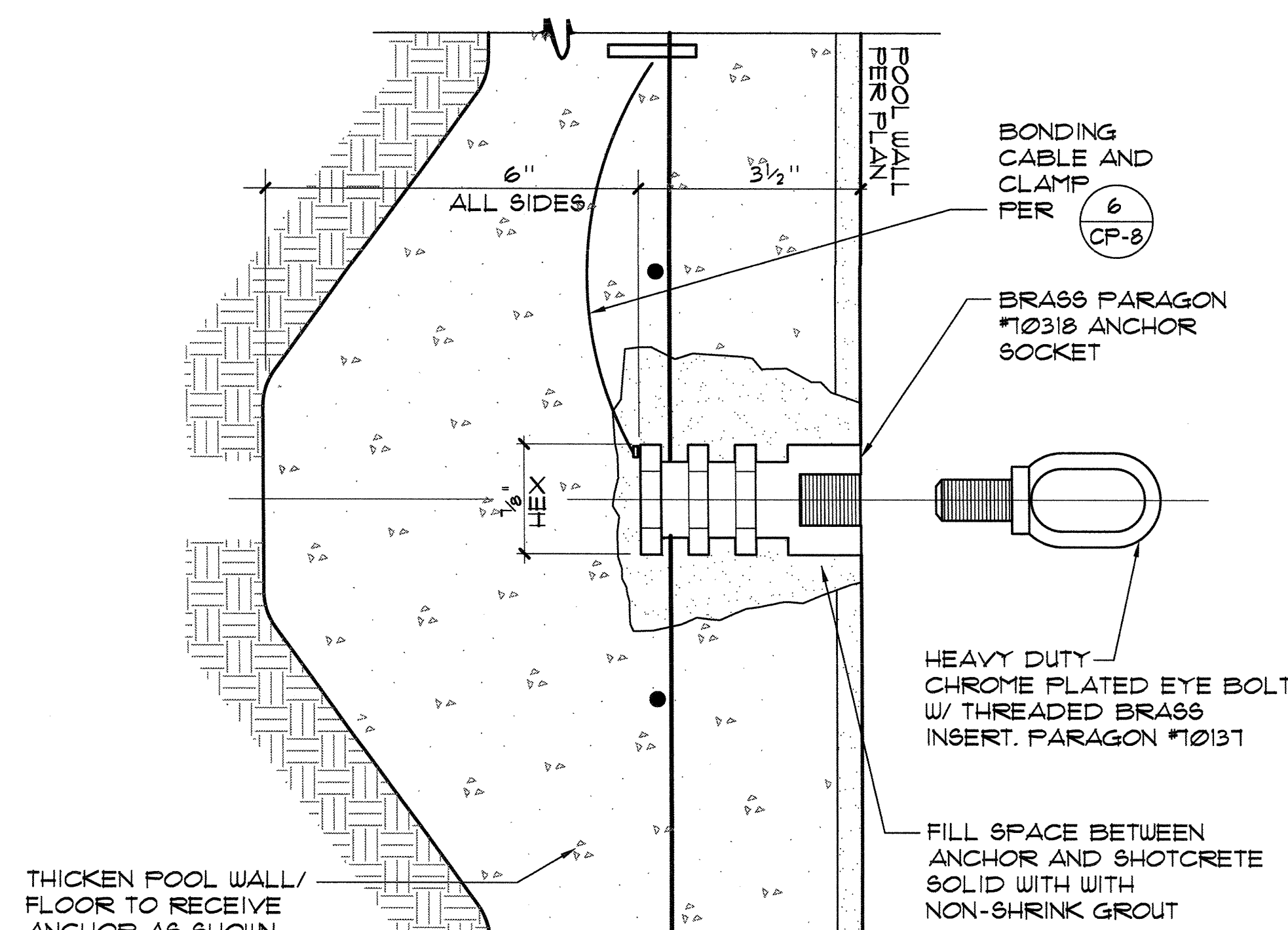

7 HEAVY EYEBOLT ANCHOR 1/2" = 1"

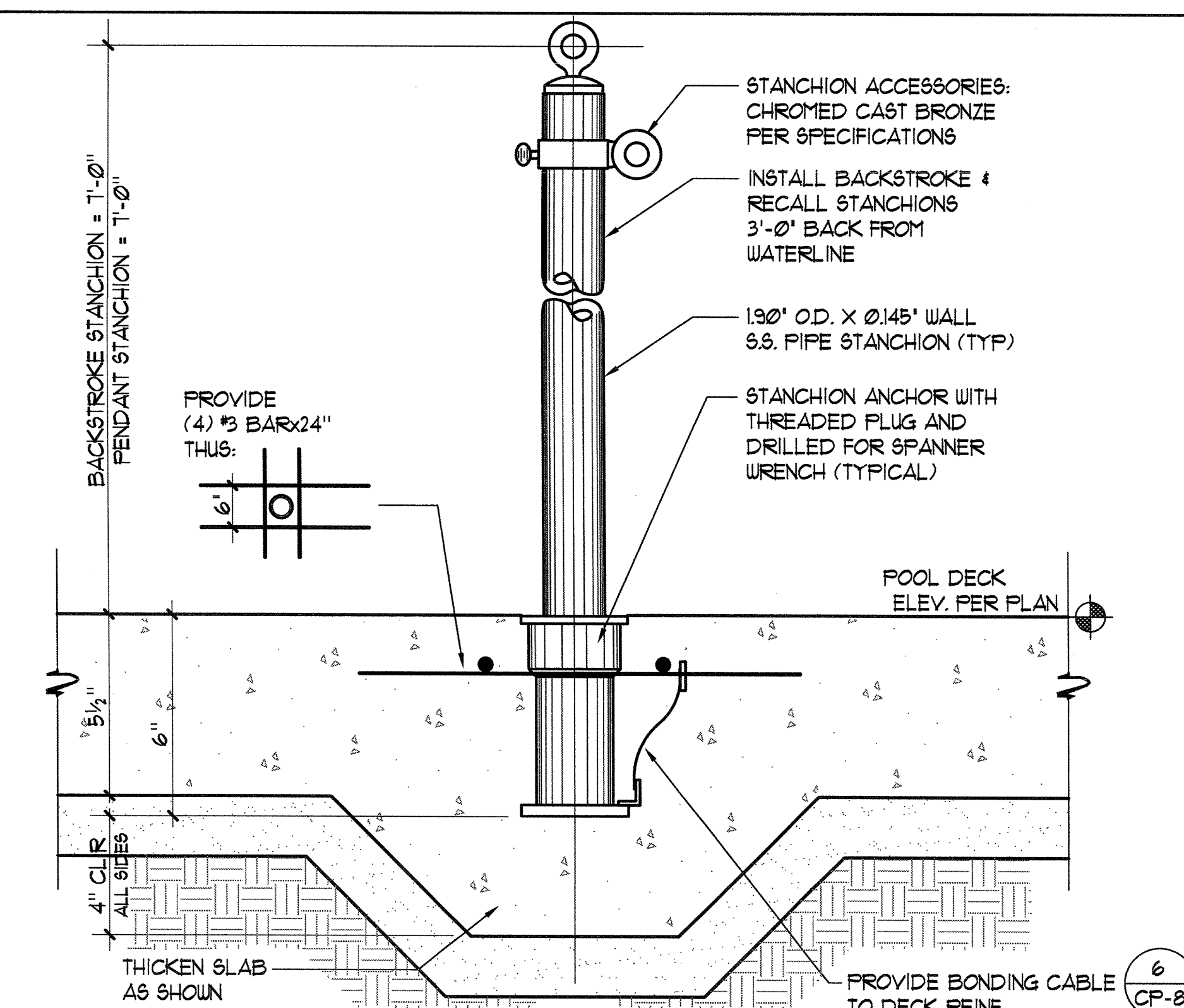

8 STANCHION POST/ANCHOR 3/4" = 1'-0"