

INSTRUCTIONAL SPACES

Design Standard

PART 1 GENERAL

1.1 PURPOSE

The design of instructional spaces must recognize the needs of the particular users, the ways the space will and might be used, its programmed capacity, and the technical requirements of the space itself. Moreover, the design of instructional spaces must recognize its principal role in the delivery of information in an evolving educational environment.

This design standard is intended to serve as a guideline for instructional spaces throughout San Mateo County Community College District. It should be viewed as a baseline standard for renovations and new construction. Specific programs may impose additional requirements which should be viewed as additive to the design standards herein.

This document can be viewed as a starting point for the design of instructional spaces. Within this document there are guidelines and templates for instructional spaces based on capacity and furnishings type. The section titled General Requirements lists standards applicable to all instructional spaces. Refer both to the General Requirements and the sections related to the specific classroom type. Finally, from this document, references are provided to materials and systems-related design standards and references.

Table of Contents:

2.1		General Requirements
	A.	Classroom Siting
	B.	Corridors and Waiting Seating
	C.	Classroom Fit Out
2.2		Classroom Capacity & Furnishing Styles
	A.	30 Seat Classrooms
	B.	45 - 50 Seat Classrooms
	C.	60+ Seat Classrooms
	D.	120+ Seat Classrooms
3.		Finishes Matrix
4.		Approved Manufacturers
5.		Substitutes Allowed
6.		Associated Design Standards and Construction Specifications

1.2 GENERAL REQUIREMENTS

A. Classroom Siting

1. Locate classrooms as close to main traffic entry doors as possible due to high traffic volume.
2. If on a floor that does not have ground level access, locate near major stairs and elevators to isolate class change noise and high traffic functions from office and lab functions.
3. Keep away from noise generating sources, such as restrooms, building system rooms, labs and hazardous material rooms.
4. Provide long walk-off mat space (at least four full steps) from exterior doors to first classroom doors to trap dirt, mud, and moisture before students reach the classroom.

B. Corridors & Waiting Seating

1. Corridors shall be sized for the load of students both leaving classrooms and those arriving for the next class. Minimum corridor size is 8' wide clear. In some instances, wider corridors are called for based on traffic patterns.
2. Corridors shall be additionally sized to allow for bench seating. Bench type seating is to be provided outside classrooms. In double-loaded corridors, benches may be located alternately side to side or be continuous on one side, except at doors. Consider fire rating requirements, maintainability, durability and comfort when detailing bench seating. Wall mounted seating or benches with open bases and easy access for floor cleaning is encouraged.
 
3. Student waiting/meeting alcoves/commons areas are encouraged along circulation paths serving classrooms. These allow groups to meet and have discussions while waiting for class changes. Waiting areas can be equipped with bulletin boards to facilitate posting of test scores and for public information use. Waiting areas should be well designed to contain noise that may be generated in such settings.

C. Classroom Fit Out

1. Shapes and Sightlines
 - a. Architect shall consider the effects of room shape on sight lines, audibility, as well as instructor/student and student/student interactions. For a traditional rectilinear configuration, strive for a maximum 2:3 ratio, with the instructional area oriented to the short side at front of room.
 - b. As much as possible, the designer should avoid the placement of structural columns within the seating area. If columns are unavoidable, seating arrangement shall take sightlines at every seat into account.
 - c. Ceiling height should be a minimum of 10'. Larger rooms will require higher ceilings in accordance with projector screen design requirements.
 - d. Doors to a classroom requiring one entrance shall be placed towards the front of the classroom. If a classroom requires more than one door, ensure that one door is placed toward the front of the classroom.

2. Telecommunications Infrastructure and Smart Classrooms

- a. All new or renovated classrooms shall be "Smart Classrooms" unless specifically stated otherwise in the building program. Smart Classroom technology includes, but is not limited to, ceiling mounted LCD projectors, wireless internet access, speakers, network and video control ports at the teaching station, technology enclosures and cabinets, projection screens and associated controls, and lighting controls.
- b. Projection screens mounted in front of the marker board must clear the board's marker tray. Typically, provide 6 – 8" clearance from the face of the marker board to the back of the screen.
- c. Placement of light fixtures must be coordinated with the projection screen, taking into consideration view ability when light fixtures are on as well as maintenance access to light fixtures for servicing.
- d. The projection screen, in its lowered position, must not obscure light switches, data ports, power receptacles, fire alarm devices, clocks, etc.
- e. Projection screens in classrooms serving 60 or fewer students do not need to be motorized, because the screen size requires a pulling force that is manageable.
- f. Projection screens in classrooms serving greater than 60 students shall be motorized.
- g. Refer to the Smart Classroom section of the Telecommunications Infrastructure Design Standard for more information.

3. Teaching Station

- a. The Teaching Station shall be at the front side of the classroom. Generally, it shall be placed to the side, away from doors, and allow the instructor to face the class while lecturing as well as while using Smart Classroom technology from the lecture podium.
- b. The Teaching Station shall include a chair for the instructor.

4. Acoustics

- a. Acoustic quality is central to the effectiveness of educational facilities. Appropriate acoustical characteristics enhance the utility of audio/visual systems, and facilitate student-teacher and student-student interactions.
- b. Refer to the Acoustical Design Standard for more information.

5. Floor Coverings

- a. Specify resilient flooring in general lecture classrooms. Refer to 09 65 00 Resilient Flooring Design Standard for more detail.
- b. Specify carpet or carpet tile in computer labs. Refer to 09 68 00 Carpet Design Standard for more detail.

6. Wall Finishes

- a. Utilize accent paint opportunities to add visual interest to the classrooms. Refer to 09 91 23 Interior Paint Design Standard for more detail.
- b. A wainscot and chair rail assembly shall be placed on the side and back walls surrounding the seating area, to add durability to the wall where flexible furniture arrangements may lead to wall scrapes and impacts. Refer to 10 26 00 Wall Protection Design Standard for more information.

7. Marker Boards

- a. Dry-erase marker boards with marker trays and a continuous tack strip at the top are required at the front of the classroom. The marker board should cover as much of the front wall as practical. At a minimum, the marker board will be 4'x16'. A useable length of marker board must be available when the projection screen(s) is/are lowered. Marker trays shall be mounted at 36" AFF.
 - b. Avoid placing fire alarm devices, switches, data ports, clocks or other devices in conflict with marker boards.
 - c. Refer to 10 11 16 Marker Board Design Standard for more information.
8. Tack Boards
- a. A single public information bulletin/tack board shall be placed adjacent to the front door, preferably on the short side of the wall towards the corner. At a minimum, the tack board will be 4'x4'. In addition, specify one additional classroom bulletin board, sized at 4'x8', for course-related information.
 - b. Avoid placing fire alarm devices, switches, data ports, clocks or other devices in conflict with tack boards.
 - c. Refer to 10 11 23 Tack Board Design Standard for more information.
9. Windows and Glazing:
- a. Use low-e glazing, tint, architectural shading elements, light shelves, and other standard methods to reduce glare and maximize daylight.
 - b. In ascertaining the best location for the teaching wall, consider cardinal orientation and select the wall that is least affected by direct sunlight in early morning and late afternoon hours, so that video projection is maximized. All things being equal, the front of class shall be selected so that windows are to the left (when facing the front of class); this minimizes shadows while note-taking for right-handed students.
 - c. If windows are provided in the classroom, provide window shade system to reduce glare, provide room darkening, as well as privacy. Refer to 12 20 00 Window Treatment Design Standard for more information.
10. Miscellaneous Specialties
- a. All classrooms must have manual pencil sharpeners. Refer to 10 00 00 Miscellaneous Specialties Design Standard for more information.
11. Mechanical Requirements
- a. Classrooms shall be individually zoned. Design air distribution equipment to minimize noise transmission from mechanical systems and adjacent spaces.
 - b. Refer to 23 00 00 Basic HVAC System Design Standard for more information.
12. Lighting Requirements
- a. The design of classroom lighting must include more than the even distribution of lighting in the room. The convenient placement of controls, their intuitive use, and recognition of the multiple forms of lighting that must be configured to support the instructional program all play a part in a successful lighting plan.
 - b. Refer to 26 50 00 Lighting Design Standard for more information.
13. Furnishings
- a. Representatives from Cañada College, Skyline College, College of San Mateo, the Technology and Facilities Maintenance operating groups, General Services and furniture industry experts formed a task force to develop a Furniture

Standards Program for typical instructional and administrative spaces. The Furniture Standards Program offers user flexibility, durability, ergonomics and comfort, favorable first costs due to volume pricing and exemplary life cycle costs due to onsite extended warranties.

14. General: Typical devices such as fire alarm devices, light switches, data ports, clocks, motion sensors, etc. shall be located per code and at set distances from edge of wall or doors to prevent disruption of wall usage and provide visual organization.

1.3 CLASSROOM CAPACITY AND FURNISHING STYLES

Classrooms shall be designed to maximize seating capacity. Each classroom shall, at a minimum, meet the stated program seating capacity. However, design team members shall not overfill classrooms with furniture to the extent that the free movement of furniture for flexible seating, if a program requirement, becomes constrained.

A. 30 Seat Classrooms

1. 30 Students Traditional, approximately 800 SF

This primary classroom type provides individual seating for 30 students, one of which is programmed for the disabled. All classrooms specified for 30 students, regardless of furnishing style, shall also be configured to fit this seating arrangement.

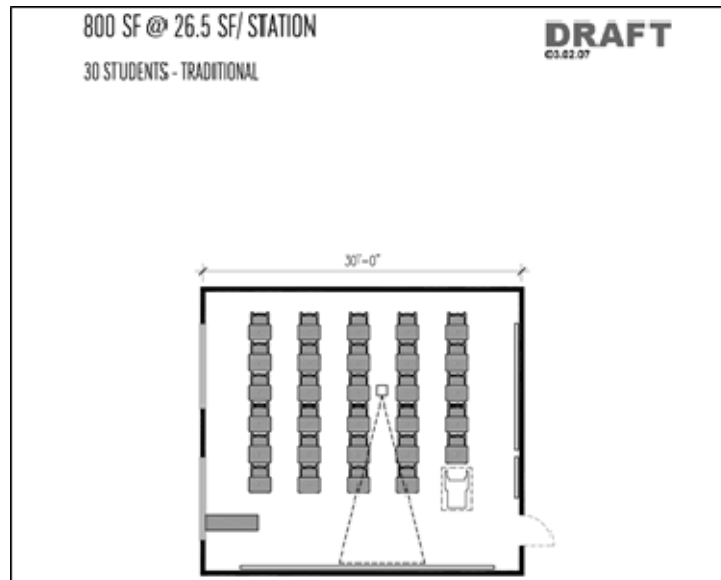

Seating type: Student desks, accessible from either side, allow for 24" x 42" seating unit size. Program may substitute tablet-arm chairs for student desks. However, the overall space shall not be reduced by using tablet-arm chairs. The accessible student station shall typically be a 24"x48" adjustable table and one chair, so that an able-bodied student may use the station when a chair-bound student is not present.

- a. Seating spacing: Individual columns of desk with an aisle on each side of desk. Desks are not permitted to be butted against each other side-to-side (to prevent student cheating). No cross aisles required.
- b. Planning module: 22 SF/Station
- c. Aisle sizes: 36" minimum except at the accessible seat position where 42" is required on one side, per code.
- d. Front of class depth: 6' to edge of first row of desks.

2. 30 Student Flexible Student Desk Groups, approximately 800 sf

This classroom type has similar specifications to the 30 Student Tables and Chairs standard, with the following exceptions:

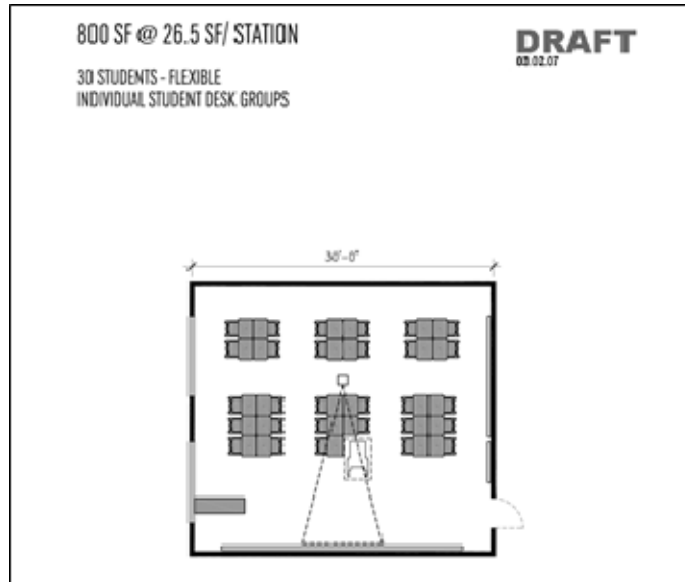

- a. Seating type: Student desks may be rearranged for group work.

3. 30 Students Tables and Chairs, approximately 800 sf

This classroom type provides pair seating at tables for 30 students, one of which is programmed for the disabled. Tables may be butted end-to-end depending on table length.

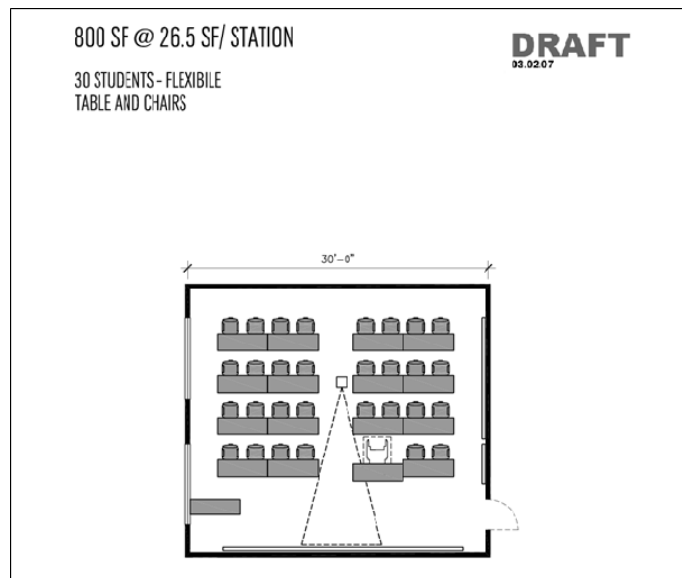

- a. Seating type: C-leg or T-leg table, 24" x 6' nominal for end-to-end configuration. Seats 2 per table. C-leg or T-leg table, 24" x 5' nominal for layout with an aisle on each side of the table. Seats 2 per table. Tables may be reduced to 18" depth on specific projects where only light reference material is anticipated. Note that 5' tables should not be butted together, as student-to-student spacing is too close for test taking.

- a. Seating spacing: 3' spacing between desks is required for chairs except where accessible seating is required. Comply with code at that location.
 - b. Planning Module: 26-28 SF/Station
 - c. Aisle sizes: 36" minimum except at the accessible seat position where code where 42" is required on one side.
 - d. Front of class depth: 6' to the edge of the first row of tables.
4. 30 Students Table and Chair Groups, approximately 800 sf

This classroom type provides pair seating at tables for 30 students, one of which is programmed for the disabled. Tables are butted front-to-front.

This classroom type has similar specifications to the 30 Student Tables and Chairs standard, with the following exceptions:

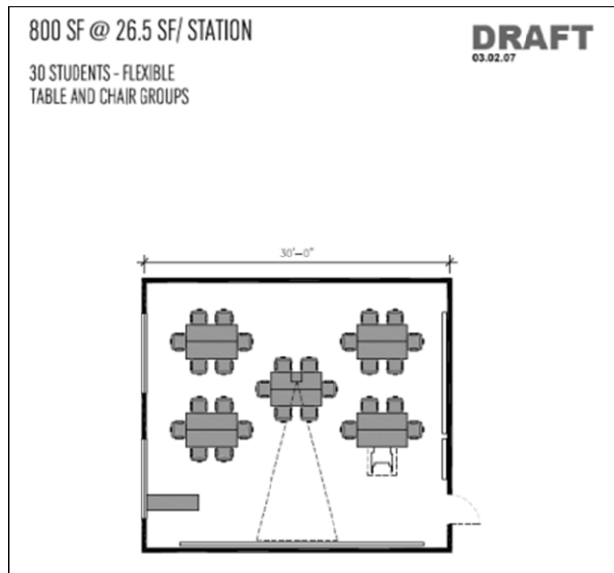

- a. Seating type: Student tables and chairs may be rearranged for group work.

5. 30 Student Tables and Chairs in Square Circle, approximately 1,100 sf

This classroom type has similar specifications to the 30 Student Tables and Chairs standard, with the following exceptions:

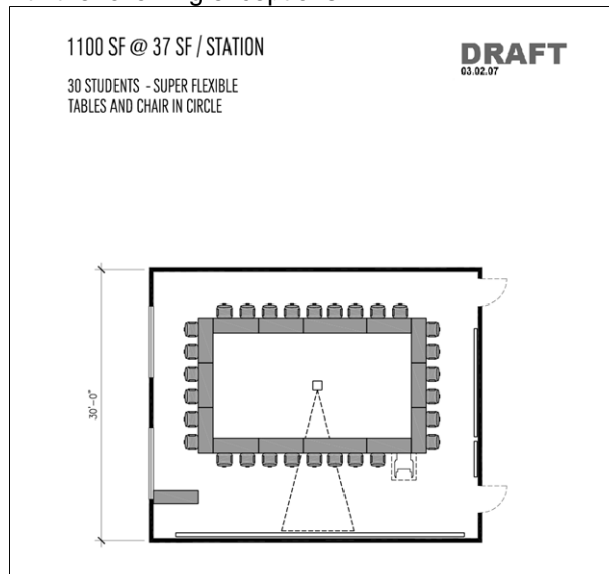

- a. Seating type: Student tables and chairs may be rearranged for group work.
 - b. Planning Module: Requires increase in allowable area to 37 SF/Station
6. 30 Student Individual Student Desks in Circle, approximately 1,100 sf

This classroom type has similar specifications to the 30 Student Traditional standard, with the following exceptions:

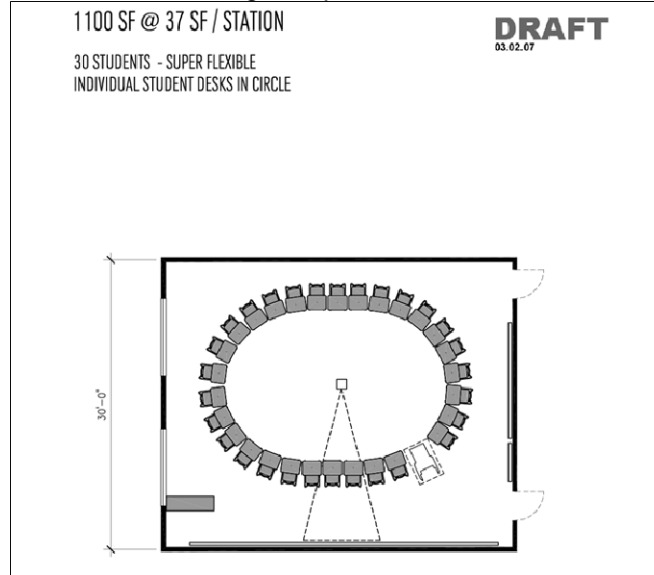

Seating type: Student desks may be rearranged for group work.

- a. Planning Module: Requires increase in allowable area to 37 SF/Station

B. 45-50 Seat Classrooms

- 1. 45-50 Students Traditional, approximately 1,100 SF

This classroom type provides individual seating for 45-50 students, one of which is programmed for the disabled. All classrooms specified for 45-50 students, regardless of furnishing style, shall also be configured to fit this seating arrangement.

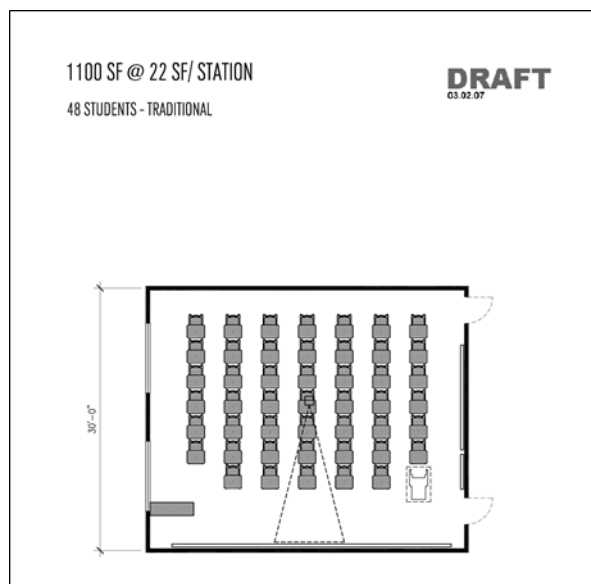

This classroom type has similar specifications to the 30 student – traditional standard with the following exceptions:

- a. Doors required: Two
 - b. Smart Classroom Technology: Comply with Telecommunications Infrastructure Design Standard, taking into account the longer viewing distance to screen.
2. 45-50 Students Tables and Chairs, approximately 1,100 SF

This classroom type provides pair seating at tables for 45-50 students, one of which is programmed for the disabled. Tables may be butted end-to-end depending on table length.

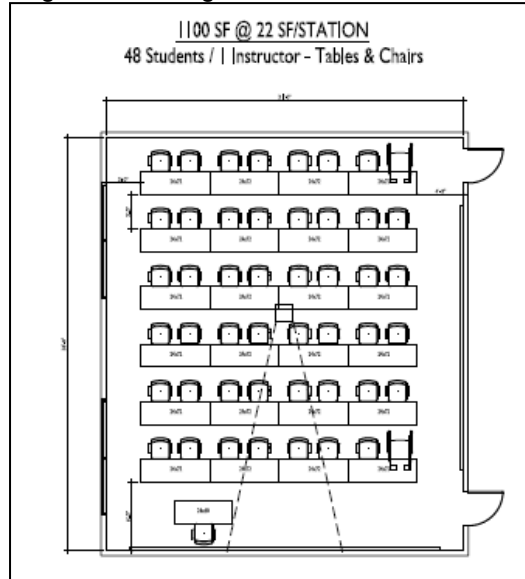

This classroom type has similar specifications to the 30 Student Traditional Classroom, with the following exception:

- a. Planning Module: 22-25 SF/Station
- b. Doors required: Two
- c. Smart Classroom Technology: Comply with Telecommunications Infrastructure Design Standard, taking into account the longer viewing distance to screen.

3. 45-50 Student Flexible Table and Chair Groups, approximately 1,100 sf

This classroom type has similar specifications to the 45-50 Students Tables and Chairs standard, except that tables and chairs can be moved for flexible group work.

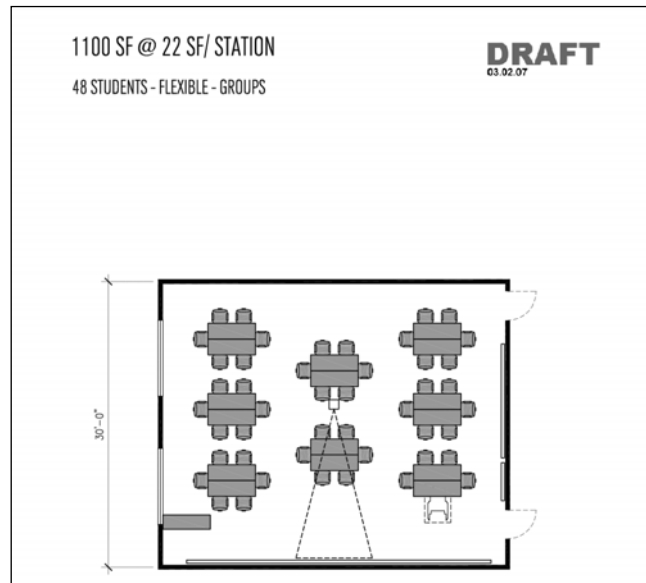

4. 45-50 Student Flexible Table and Chair Groups, approximately 1,100 sf

This classroom type has similar specifications to the 45-50 Students Tables and Chairs standard, except that chairs can be moved for flexible group work.

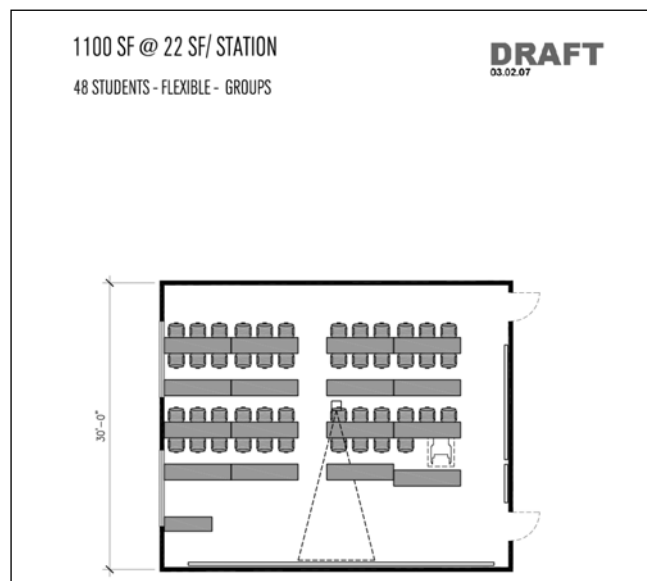

5. 45-50 Student Tiered Fixed Seating, approximately 1,200 sf

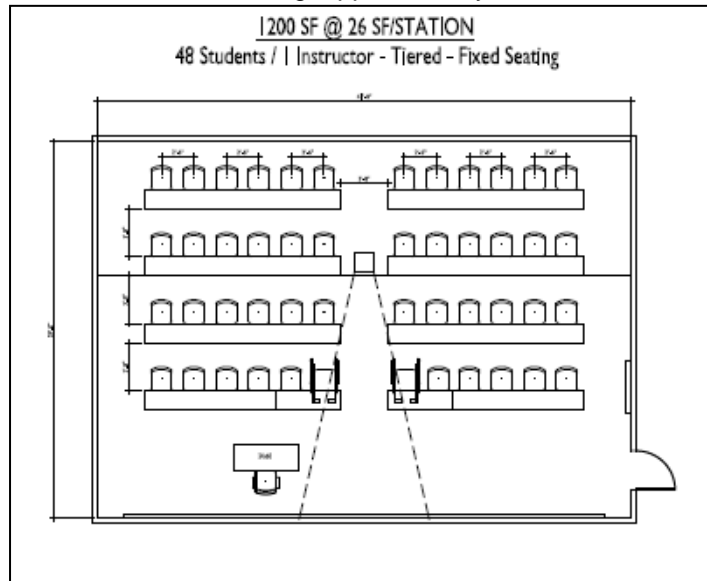

- a. Seating type: KI University Seating with 360 degree seat rotation for collaborative work.
- b. Seating spacing: 3' spacing between seats except where accessible seating is required. Comply with code at that location.
- c. Planning Module: 22-25 SF/Station
- d. Tiered seating: As required by program. SMCCCD encourages placement of two rows of University Seating per tier, to facilitate collaborative instructional pedagogy.
- e. Front of class depth: Allow for instructors table to be placed toward center front of room. Ordinate this position with controls for lighting and audio, and to avoid projection sightline conflicts.
- f. Marker Boards: 1 - 4' x length of front wall, plus additional side wall marker boards. Program may require sliding marker boards to maximize marker board area (vertical or horizontal sliders). Comply with 10 11 16 Marker Board Design Standard.
- g. Smart classroom technology: Comply with Telecommunications Infrastructure Design Standard. Classrooms with greater than 100 student seats shall have minimum two projectors and screens.
- h. Wainscot: Not required; fixed seating does not damage walls.

C. 60 Seat Classrooms

1. 60 Student Tiered University Seating, approximately 1,250 sf

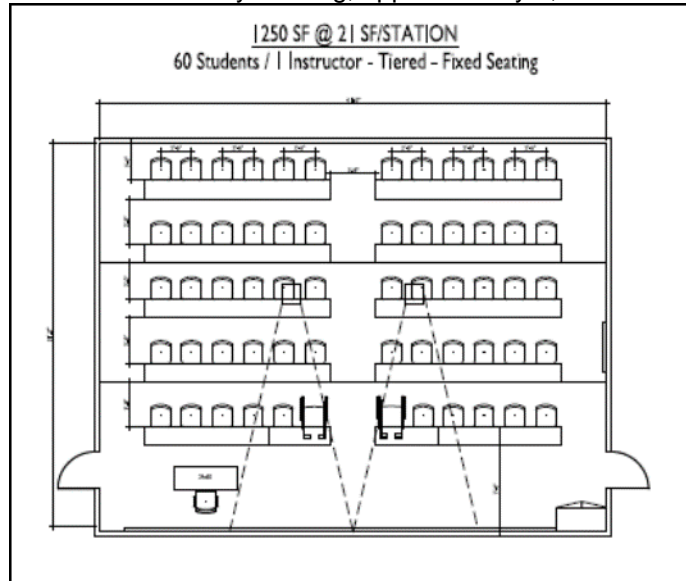

- a. Seating type: KI University Seating
 - b. Seating spacing: 3' spacing between seats except where accessible seating is required. Comply with code at that location.
 - c. Planning Module: 21 SF/Station
 - d. Tiered seating: Required. SMCCCD encourages placement of two rows of University Seating per tier, to facilitate collaborative instructional pedagogy.
 - e. Front of class depth: Allow for instructors table to be placed toward center front of room. Coordinate this position with controls for lighting and audio, and to avoid projection sightline conflicts.
 - f. Marker Boards: 1 - 4' x length of front wall, plus additional side wall marker boards. Program may require sliding marker boards to maximize marker board area (vertical or horizontal sliders). Comply with 10 11 16 Marker Board Design Standard.
 - g. Smart classroom technology: Comply with Telecommunications Infrastructure Design Standard. Classrooms with greater than 100 student seats shall have minimum two projectors and screens.
 - h. Wainscot: Not required; fixed seating does not damage walls.
 - i. Doors required: Two
2. 60 Student Non-Tiered University Seating, approximately 1,250 sf
- a. Seating type: KI University Seating
 - b. Seating spacing: 3' spacing between seats except where accessible seating is required. Comply with code at that location.
 - c. Planning Module: 21 SF/Station
 - d. Tiered seating: Not required

- e. Front of class depth: Allow for instructors table to be placed toward center front of room. Coordinate this position with controls for lighting and audio, and to avoid projection sightline conflicts.
- f. Marker Boards: 1 - 4' x length of front wall, plus additional side wall marker boards. Program may require sliding marker boards to maximize marker board area (vertical or horizontal sliders). Comply with 10 11 16 Marker Board Design Standard.
- g. Wainscot: Not required; fixed seating does not damage walls.
- h. Doors required: Two

D. 120+ Seat Classrooms

1. 126 Student Tiered Theater Seating, approximately 1,600 sf

This theater-type lecture hall provides individual theater seating with flip up tablet arms to be configured on tiers. Aisles are provided at the ends. Accessible seating is provided along the front row.

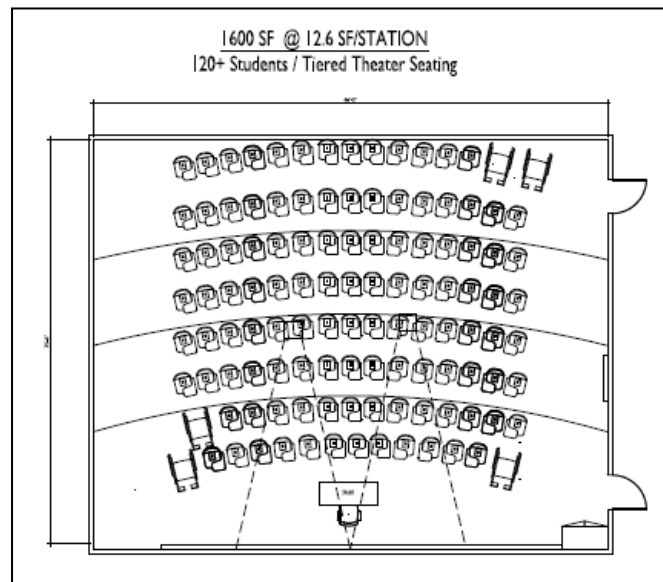

- a. Seating type: Lancaster Room shape: Fan preferred. Rectangular requires an acoustical study for attenuation treatment along sidewalls and back wall.
- b. Room entrance: Bottom of theater
- c. Planning module: 12.6 SF/Station
- d. Seating spacing: Based on conventional criteria for height and chair spacing.
- e. Tiered seating: Yes. Tablets shall be oversized, and both receding and flip-up.
- f. Front of class depth: Allow for instructors table to be placed toward center front of room. Coordinate this position with controls for lighting and audio, and to avoid projection sightline conflicts.
- g. Marker Boards: 1 - 4' x length of front wall, plus additional side wall marker boards. Program may require sliding marker boards to maximize marker board area (vertical or horizontal sliders). Comply with 10 11 16 Marker Board Design Standard.
- h. Wainscot: Not required; fixed seating does not damage walls.
- i. Doors required: Two

- j. Smart classroom technology: Comply with Telecommunications Infrastructure Design Standard. Classrooms with greater than 100 student seats shall have minimum two projectors and screens.

2. 126 Student Tiered University Seating, approximately 2,300 sf

This lecture room type provides seating along a contiguous arc-shaped top interrupted only at aisles. Seating is fixed to the table base. Aisles are provided at ends and middle. Accessible seating is provided along the front row. Cantilever design minimizes housekeeping.

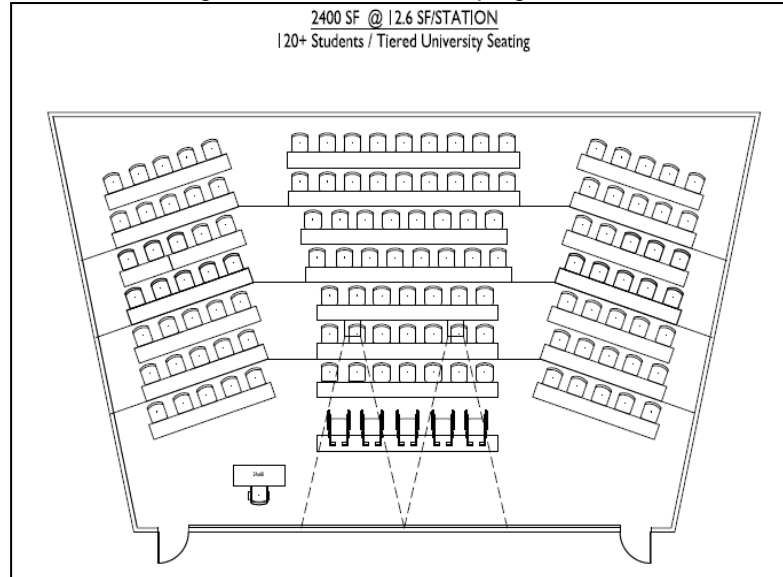

- a. Room shape: Fan preferred. Rectangular requires an acoustical study for attenuation treatment along sidewalls and back wall.
- b. Seating type: KI University Seating
- c. Seating spacing: 3' spacing between seats except where accessible seating is required. Comply with code at that location.
- d. Room entrance: Bottom of theater.
- e. Planning module: 18 SF/Station
- f. Tiered seating: Yes. SMCCCD encourages placement of two rows of University
- g. Seating per tier, to facilitate collaborative instructional pedagogy.
- h. Front of class depth: Allow for instructors table to be placed toward center front of room. Coordinate this position with controls for lighting and audio, and to avoid projection sightline conflicts.
- i. Marker Boards: 1 - 4' x length of front wall, plus additional side wall marker boards. Program may require sliding marker boards to maximize marker board area (vertical or horizontal sliders). Comply with 10 11 16 Marker Board Design Standard.
- j. Wainscot: Not required; fixed seating does not damage walls.
- k. Doors required: Two
- l. Smart classroom technology: Comply with Telecommunications Infrastructure Design Standard. Classrooms with greater than 100 student seats shall have minimum two projectors and screens.

PART 2 PRODUCT

2.1 FINISHES MATRIX – INSTRUCTIONAL SPACES

Finishes Matrix							
Space Category	Floor	Wall	Base	Ceiling	Door	Minimum Ceiling Height	Remarks
Lecture Halls	RF	GB	RTB	AT	WD	10'-0"	
Laboratory Wet	RF	GB	RTB	AT	WD	9'-0"	
Laboratory Dry	RF	GB	RTB	AT	WD	9'-0"	
Library Reading	CPT	GB	RTB	AT	WD	9'-0"	
Library Stacks	CPT	GB	RTB	AT	WD	10'-0"	
Gymnasium	W	GB/W	W	GB/ES	WD	25'-0"	Wood Wainscot 8' High
Dance	W	GB/M	W	GB/AT	WD	12'-0"	
Wresting	R/W	GB/W	W	GB/AT	WD	12'-0"	Padded Wainscot
Fitness Center	R/W	GB/M	W	GB/AT	WD	12'-0"	

Abbreviation Key				
Floors	Ceiling	Walls	Doors	Base
CON Sealed Concrete	AT Acoustic Ceiling	CMU Painted or Sealed Concrete Masonry Units	SF Storefront	RTB 4" Rubber Topset Base
CPT Carpet	ES Exposed Structure, Painted	CON Sealed Concrete	MT Metal	CON Concrete
CT Ceramic Tile	GB Painted Gypsum Board	CT Ceramic Tile	WD Wood, Solid Core, with Vision Panel	CT Ceramic Tile
QT Quarry Tile	W Wood	ES Exposed Structure, Painted as Appropriate	FRP Fiber Reinforced Polymer	QT Quarry Tile
RF Resilient Flooring		GB Painted Gypsum Board		W Wood
W Wood		VWC Vinyl Wall Covering		NB No Base

SC Stained Concrete		W Wainscot		
R Rubber		M Mirror		

2.2 APPROVED MANUFACTURERS

- A. Not Applicable

PART 3 EXECUTION

3.1 SUBSTITUTES ALLOWED

- A. Not Applicable

3.2 ASSOCIATED DESIGN STANDARDS AND CONSTRUCTION SPECIFICATIONS

Space Design Standard – Space Allocation Guideline

Space Design Standard – Administrative Spaces

Space Design Standard – Circulation, Public & Utility Spaces

Acoustical Design Standard

Furniture Finishes Design Standard

Physical Access Control & Security Management Design Standard

Telecommunications Infrastructure Design Standard

09 65 00 Resilient Flooring Design Standard

09 68 00 Carpet Design Standard

09 91 23 Interior Paint Design Standard

10 00 00 Miscellaneous Specialties Design Standard

10 11 16 Marker Board Design Standard

10 11 23 Tack Board Design Standard

10 26 00 Wall Protection Design Standard

12 20 00 Window Treatment Design Standard

12 48 13 Entrance Floor Mats and Frames Design Standard

23 00 00 Basic HVAC System Design

26 50 00 Lighting Design Standard

END OF SECTION